

TH
2301
M3

UC-NRLF

#C 160 443

HOW TO FRAME A HOUSE

YD 02774

77

LIBRARY OF

JOHN GALEN HOWARD

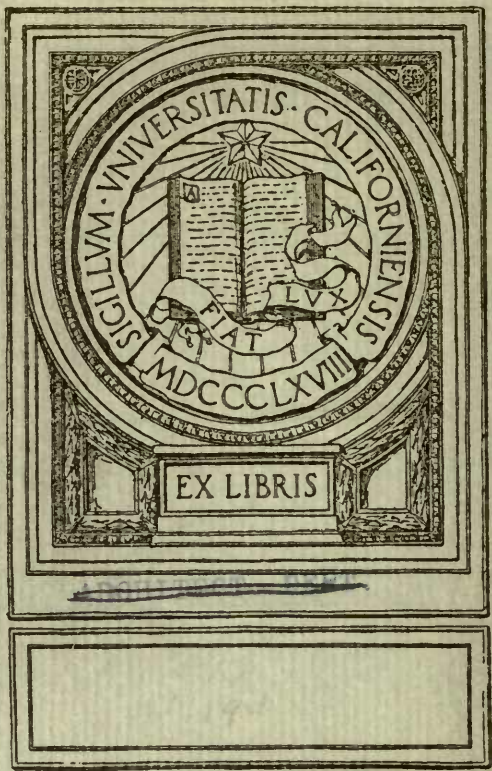

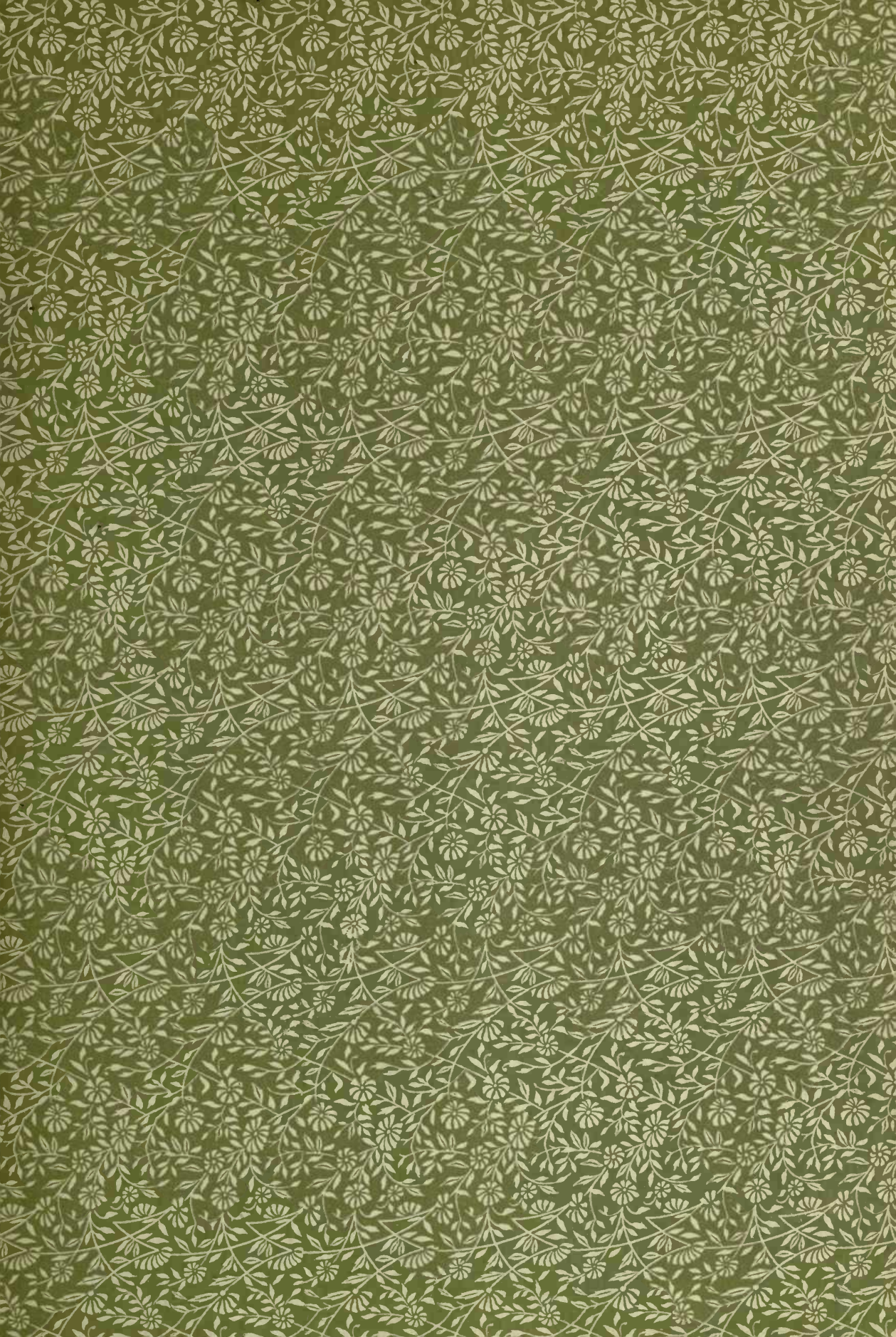

LIBRARY OF
COLUMBIA

HOW TO FRAME A HOUSE

OR

House and Roof Framing,

By OWEN B. MAGINNIS,

"

Author of "Bricklaying," "Practical Centring" "How to Join Mouldings" Etc., Etc.

A PRACTICAL TREATISE ON THE LATEST AND BEST METHODS OF LAYING OUT,
FRAMING AND RAISING TIMBER HOUSES ON THE BALLOON PRINCIPLE,
TOGETHER WITH A COMPLETE AND EASILY UNDERSTOOD
SYSTEM OF ROOF FRAMING, THE WHOLE MAKING

A Valuable and Indispensable Book for Carpenters, Builders, Foremen, Journeymen, Etc.

ILLUSTRATED

And Explained by numerous Large Engravings of Houses, Roofs, Etc.

PUBLISHED BY
OWEN B. MAGINNIS, NEW YORK.
1901.



Gift of John Calvin Howard
~~ARCHITECT. DEPT.~~

TH
2301
M3

PREFACE.

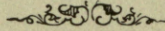

AS the best systems of framing timber dwellings now universal throughout this country and Canada are contained in this book, I need only say in placing the Sixth edition before the trade that it contains the very latest and best methods of Laying out, Framing and raising House Frames.

Every builder in the land will find it useful, in fact valuable, in his practice, and every carpenter, necessary in his work. That it will be appreciated is now without doubt, and I trust that it may prove a means of making money and saving labor to every one who buys it.

My best thanks are due Mr. P. J. McGuire, editor of "The Carpenter," for permission to reproduce "Roof Framing."

Respectfully,

NEW YORK, 1901.

THE AUTHOR

COPYRIGHTS 1891-1893.



CONTENTS.

PART I.—Balloon and Braced Frame Houses.

- CHAPTER I. General Description of Balloon Frames, Framed Sills, and their construction.
- CHAPTER II. First Floor Beams or Joists, Story Sections, Second Floor Beams, Studding, Framing of Door and Window Openings, Wall Plates and Roof Timbers.
- CHAPTER III. Laying Out and Working Balloon Frames, Girders, Sills, Posts and Studding.
- CHAPTER IV. Laying Out First and Second Floor Joists or Beams, Ceiling Joists and Wall Plates.
- CHAPTER V. Laying Out and Framing the Roof.
- CHAPTER VI. Raising.
- CHAPTER VII. Braced Frame Houses; How to Lay Out, Frame and Construct them.
- CHAPTER VIII. How to Frame Out Bay Windows.
- CHAPTER IX. The Construction of Framed Tenements and Factories.
- CHAPTER X. How to Construct a Timber Framed Auditorium.
- CHAPTER XI. The Construction of Reviewing Stands.
- CHAPTER XII. How to Build a Timber Grain Elevator.
- CHAPTER XIII. Framing Projecting Stories and Bay Windows, also General Hints.
- CHAPTER XIV. How to Frame Cheap Timber Bridges for Roadways, etc.
- CHAPTER XV. How to Frame a Log Cabin.

PART II.—How to Frame the Timbers for a Brick House.

Copyrighted 1876, by Owen B. Maginnis.

- CHAPTER I. General Description, First Story Fireproof Floors, Wood Floor Beams and Studding.
- CHAPTER II. Second and Upper Story Beams, Partitions, Bridging and Angular Framing.
- CHAPTER III. Fireproofing Wood Floors, Partitions and Doors.
- CHAPTER IV. Roofs, Bulkheads and Fronts.
- CHAPTER V. Composite, or Wood and Iron Construction.
- CHAPTER VI. Heavy Beams and Girders, and Raising same.

PART III.—Roof Framing.

- CHAPTER I. Simple Roofs.
- CHAPTER II. Hip and Valley Roofs.
- CHAPTER III. Roofs of Irregular Plan.
- CHAPTER IV. Pyramidal Roofs.
- CHAPTER V. Hexagonal Roofs.
- CHAPTER VI. Conical or Circular Roofs.
- CHAPTER VII. Framing, Sheeting and Slating an Eyebrow Window.

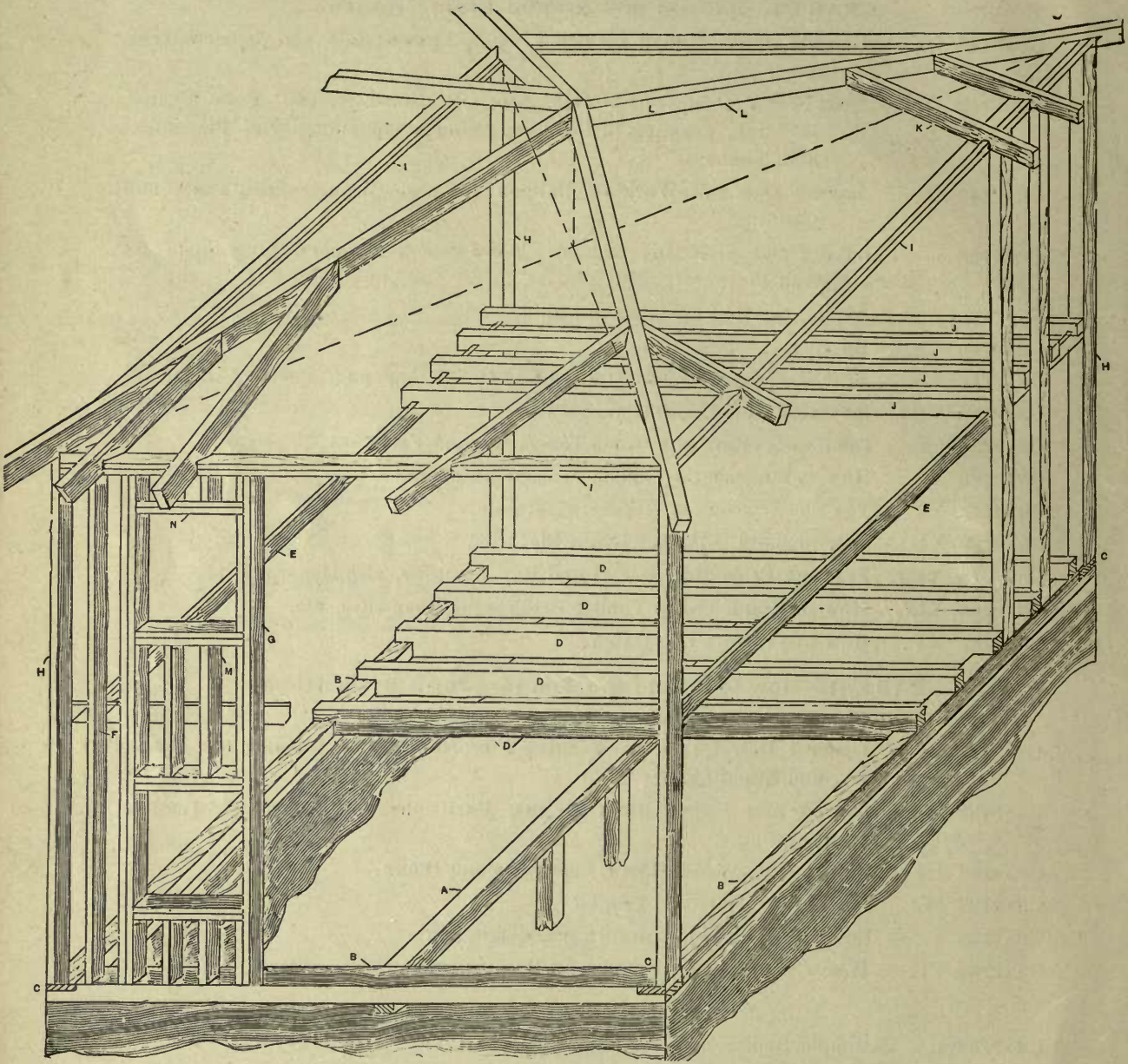

FIG. 1—SKELETON VIEW OF A BALLOON FRAME.

Balloon and Braced Frame Houses.

CHAPTER 1

GENERAL DESCRIPTION—FRAMED SILLS AND THEIR CONSTRUCTION.

AS the majority of houses which are erected throughout the United States and Canada are now built of wood on the system which is best known as that of "Balloon Framing," I think that some practical information on this subject will be appreciated. Except where very heavy timbers are used, as in the construction of frame factories, barns, sheds, etc., the old tenon, mortise and pin method is now obsolete. The economical and excellent structural methods of framing on the balloon system have made it universally popular with all architects, builders and carpenters. There has never yet been anything really practical written about it, and I feel assured that this book will be favorably received. Some readers will, no doubt, feel inclined to criticise many of the methods published, and from them I would ask a little consideration, as those which will be illustrated are not my invention, but are in vogue and daily application in many States and localities. However, that readers in general may gain information from them is my great desire.

Balloon frames are probably termed thus because of their extreme lightness and rigidity, as they embody some of the characteristics of the balloon, including simplicity of construction and uniformity of outline, but as Mr. Woodward says in his useful little book, "Modern Homes," basket frames would be more appropriate

name for them, as their construction partakes much of the basket pattern—that is to say, they have upright stays or studs, but wood instead of willow covering. Balloon frames may be divided into three principal component parts, consisting of the floors, the walls and the roof.

Fig. 1 of the illustrations will give the reader a first conception of what is meant by a balloon frame. Taking it for granted that he is a practical and intelligent man who wishes to understand the principal parts of a house, he will readily perceive the parts just mentioned. The floors are made up of smaller pieces, or what is practically called timbers, and each of these timbers has its own appellation, and serves a useful purpose in the construction. A is the cellar or main supporting girder, which is placed in the cellar of the house in order to sustain the weight of the floor joists, partitions, or other weights placed upon it. It is either made up of one stick of timber or built up in thicknesses, or several timbers 2x8, 2x10 or 2x12, joists spiked or bolted together to form, as it were, one large timber 8x10 or 8x12, as the case may be. It is supported in the centre of its length by posts equally spaced between the walls, on which the ends rest and in which they are usually inserted from 6 to 9 inches. The top edges are placed level with the top of the foundation wall, set on the cellar wall or underpinning. B represents the sills, of

which there are four for this building, which has four sides. If a building have more sides it must have a sill for each on which to rest the posts and studding. They are usually made of timbers measuring 4x6 inches, and are halved together in the corners in the manner shown at C. For the sake of economy, however, some builders prefer to build up their sills in two thicknesses of two-inch plank, spiking them thoroughly together and overlapping the corners in the manner shown at Fig. 2. This method is not as good as that described before, but it is cheaper, as it saves the cost of thick timbers and the labor of halving the corners.

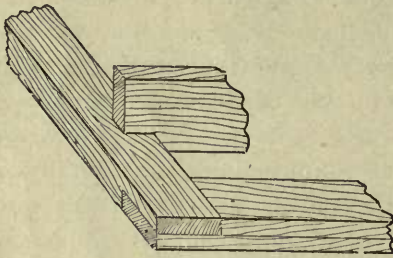

FIG. 2.

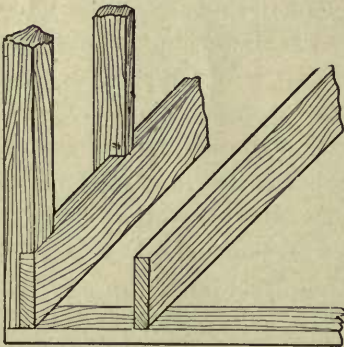

FIG. 3—FRAMING OF SILLS.

Fig. 3 is another method of building sills resorted to for the purpose of saving labor. It will be noticed that the floor beams play an important part in the construction of this description of sill, and it is therefore open to criticism. Referring again

to Fig. 1, the first floor beams will be seen at D D D. It will be noticed that they rest on the cellar girder, A, are notched or girded over the sills, B B, and their bottom edges rest on the stonework or the foundation or cellar walls.

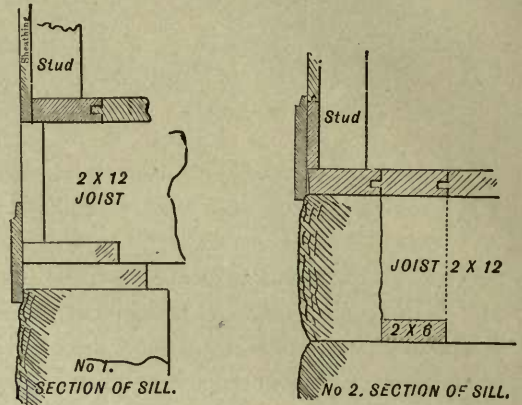

FIG. 4—CHEAP SILLS.

At Fig. 4 I show two more arrangements of sills which are even cheaper than the foregoing, inasmuch as they are made up of ordinary floor timbers spiked together, so as to form, as it were, box sills. For very cheap work, as small houses or barns, they can be readily and economically introduced. No. 2 is especially suitable for barns, as it does away with much timber and labor, but it must be remembered that incomplete sills of this description or character should never be introduced when a few dollars can be spared to put in one of a better and more suitable form. Any sensible mind will readily understand that such sills must necessarily follow the settlement of the stone underpinning, and should this be uneven, the whole superstructure will, as a matter of consequence, strain and become injured. Some architects in the West, probably from a desire to cheapen their productions, promote such construction as this, but they are certainly not fit, and are better not put in.

In proceeding, I think it best to give the reader, especially the beginner and young mechanic, a general description of the principal component parts of a simple house framed on the balloon system. Then by chapters to instruct him practically in the various practical means and methods which must be followed when building houses of this class. I therefore most respectfully ask those who wish to apply them in actual practice to become thoroughly acquainted with those important instruments or tools absolutely necessary to proceed accurately, namely: The two-foot rule, ten-foot pole, and steel square. The last combines a'almost all three.

CHAPTER II.

FIRST FLOOR BEAMS OR JOISTS—STORY SECTIONS—SECOND FLOOR BEAMS—STUDDING—FRAMING OF DOOR AND WINDOW OPENINGS—WALL PLATES AND ROOF TIMBERS.

The isometrical drawing, Fig. 1, shows how the joists are spaced at equal distance apart, generally 14 inches between the faces or 16 inches from centre to centre for ordinary dwelling houses, and on them the flooring laid. These beams are framed or sawn out to fit over the sill their own thickness, and to rest on the stone-work of the cellar wall or underpinning, also to

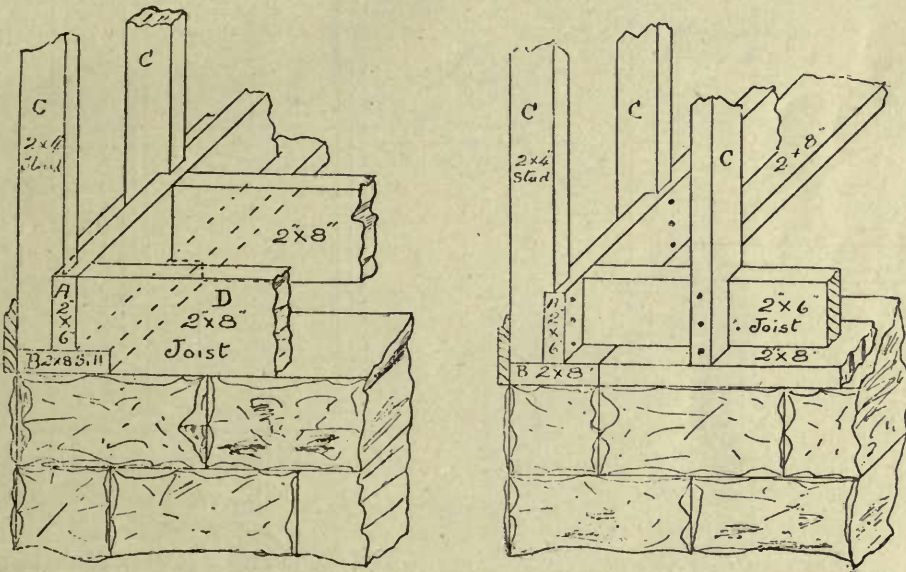

FIG. 5—TWO MORE EXAMPLES OF SILL CONSTRUCTION.

To illustrate, B is a 2x8 placed on the wall, and A is a 2x6 spiked fast to it; C is a 2x4 studding spliced firmly to A and B; D is spiked in the same manner, the end and side sills are both made the same way and spiked well at the corners, making a first-class box sill, and one that can be relied on in a cyclone.

rest on or be supported by the cellar girder; from this it will be seen that the cellar girder is set fair with the top of the wall. H, H, H, H are the posts or four main angle uprights of the frame, and, for reasons which I can hardly explain, are made in various ways in different States. Those I have drawn in this sketch are 4"x6" tim-

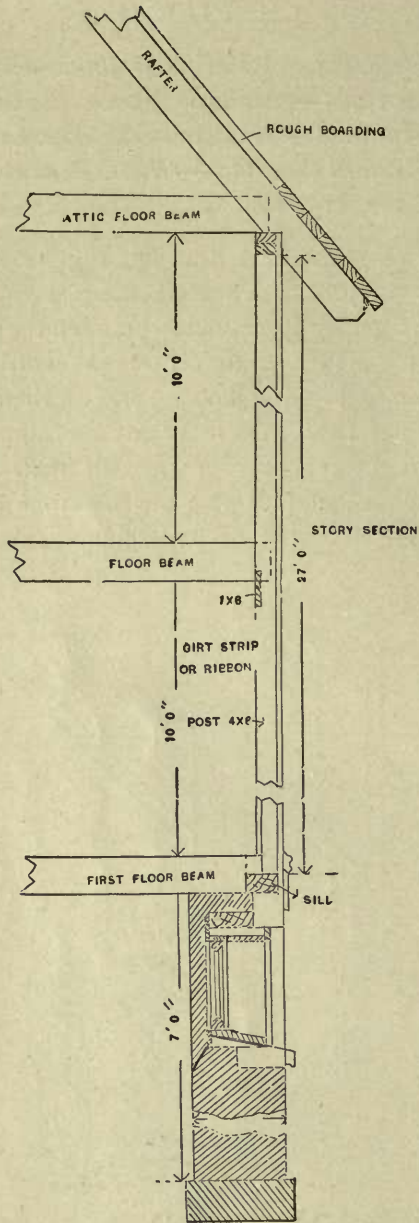

FIG 6—SECTION OF WALL.

bers, and this is the method usually followed in the Eastern States. In the West, however, the posts are made of two 2x4, spiked together so as to form one stick or timber, but the solid posts are preferable. These are simply cut to the length required, with the top and bottom ends perfectly square, so that they may be nailed solidly

on the sill at the bottom and support the wall plate properly at the top. E, E are the girt strips or, as they are better known, "ribbons," on which the second floor joists or beams rest. They are gained into the posts and studding on the right and left side walls of the frame. A study of the story section, Fig. 6, will give the student a more comprehensive explanation of the framing of the floor timbers and gaining of the posts and studding, than would be conveyed by Fig. 1.

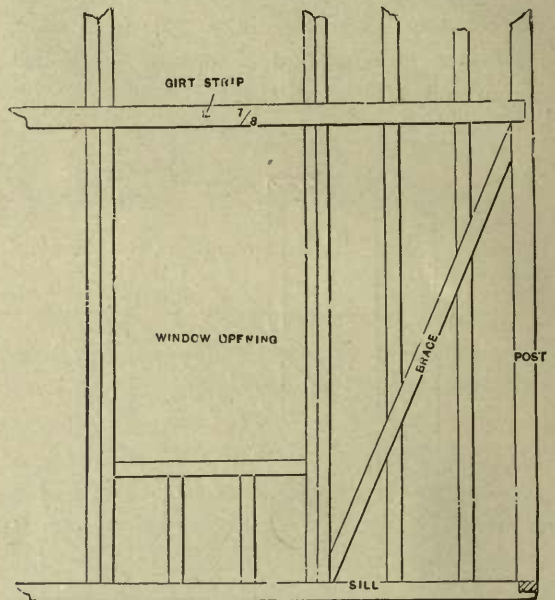

FIG. 7—ELEVATION OF A STUD WALL WITH BRACE.

The second floor joists should be notched out to sit down on the ribbon in the way shown in Figs. 1, 6 and 14, to hold the side walls together. The wall studs are invariably spaced 16 inches between centres; many readers who are young at the business may ask why? The reason is a very simple one. It is because all plasterers' laths are cut or sawn to a standard length, viz.: 4 feet long, and it is for the purpose of overlapping and breaking the joints on the lath that they are thus spaced. Of

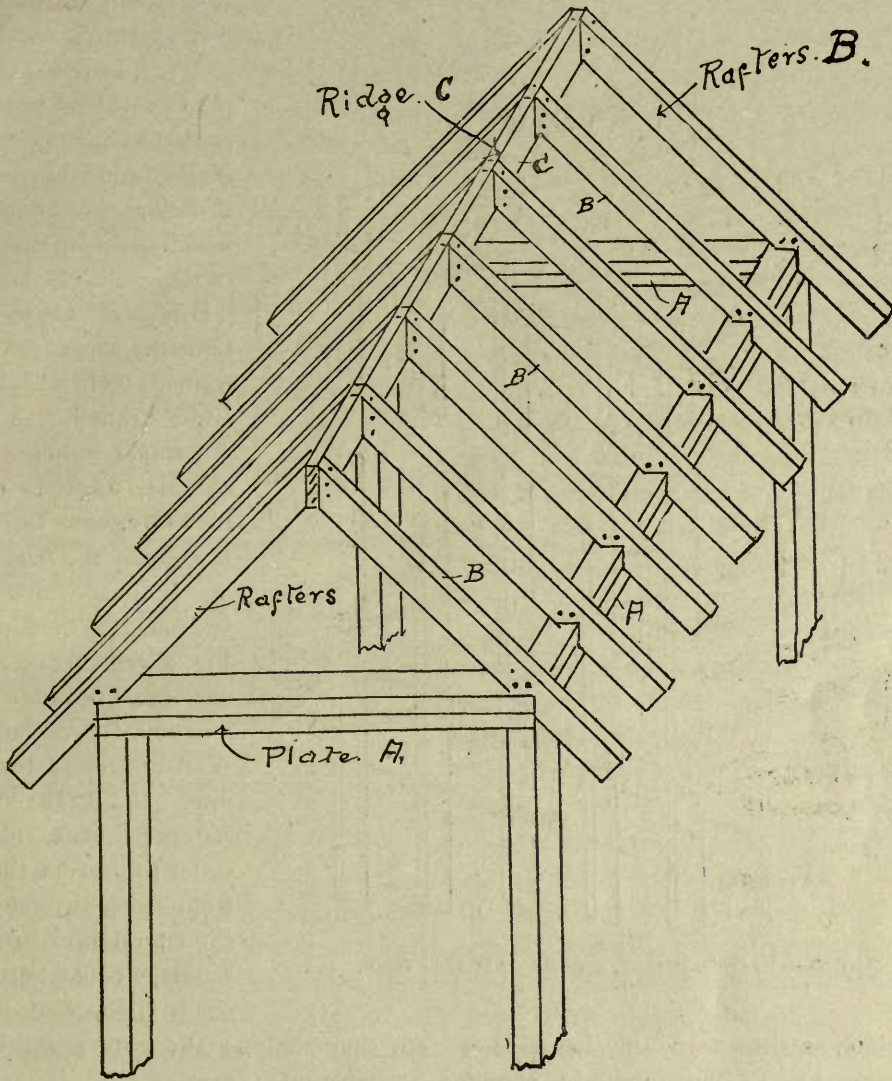

FIG. 8—ROOF TIMBERS SET UP.

course it will be easily seen that three times sixteen inches make four feet, or the standard length of a plasterer's lath, and one lath will therefore nail on four studs and cover three sixteen inch lengths.

Openings for windows are obtained in the manner represented on the left in the front of Fig. 1. For extra strength, and by reason of the weakening by introducing the openings, it is the custom to double up the studding on each side of them, and this is done as follows: A single stud, as

G, is first inserted and nailed in on each side of the opening. Then the top and bottom headers, as M and N, are cut to the necessary length and placed in, bevelled and nailed. The top or upper header is generally doubled, but the bottom one need not necessarily be so, though I have drawn it doubled here as it is often done in good work. When these are in a short stud is cut in to form the double thickness. In the better class of framed houses the doubled studs are put in full length from

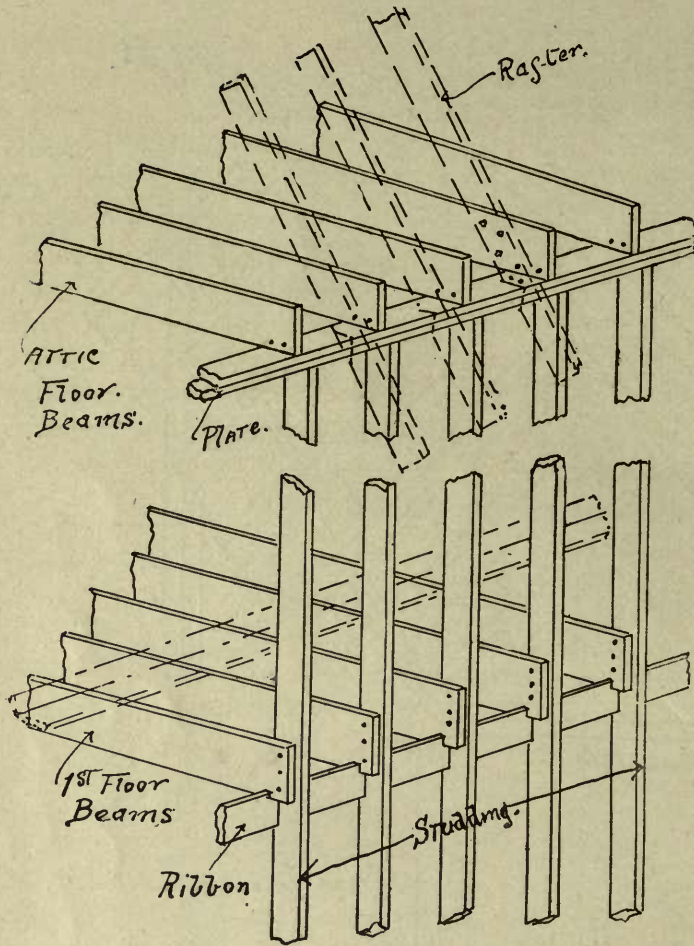

FIG. 9—FLOOR JOISTS, STUDS AND RAFTERS.

sill to plate, as shown on the left side of the opening, Fig. 1. This method is shown in Fig. 7, which is an inside view of the stud wall standing upright, with the girt strip or ribbon gained in and nailed with a brace cut in to stay the building. The second floor joists are spaced out the same distance between centres as those forming the first floor below—that is, 16 inches between centres. J, J shows them in position on the ribbon, Fig. 1. Door openings likewise have the studding doubled both on outside and inside walls, and when the openings are over four feet wide the headers have a trussing arrangement placed

over them to sustain the weight above, see Fig. 12.

I, I, I, I are the four wall plates, which, being supported by the upright studding forming the framework of the walls, carry the rafters which make up the framing of the roof. L, L are the "Hip" or angle rafters. Outside angle rafters are termed "Hips!" Inside angle rafters "Valleys." As this building has four outside angles, it has, therefore, four hip rafters. K denote the "Jack" rafters or those which are cut and nailed to the hip rafters. Fig. 8 represents an ordinary peak or ridge roof on a common oblong plan. A, A are the plates as before. B, B, the common rafters; C, the ridge. In order to prevent the plates from being thrust out by the lateral pressure of the rafters, a collar beam or tie beam is inserted, see Fig.

16, thus making the roof a stable, solid construction.

Fig. 9 will convey to the reader or student how the side of a balloon frame is put together. The first floor beams are 2"x8", gained out and set on the ribbon which is let into the studding its full thickness, and nailed fast to each stud; on the upper ends the wall plate rests, and is nailed thereto, being made of two thicknesses of 2"x4" joist. The other top or attic floor beams, which are also tie beams, 2"x6", are set and spaced off on this, also the roof timbers or rafters of 2"x4" scantling. From this drawing the construction of the

section, Fig. 6, will be readily understood. As the timbers of balloon frames are held together entirely by nails, I would ask readers to note the nailing shown in these sketches, for they represent how the timbers are fastened together in order to form a complete frame.

CHAPTER III.

LAYING OUT AND WORKING BALLOON FRAMES, GIRDERS, SILLS, POSTS AND STUDDING.

In the first and second chapters I have endeavored to explain to the student the principal timbers forming the balloon frame of a simple house, built on a square plan, or on a square foundation. In this chapter the student or beginner will be shown the proper mechanical way to proceed in laying out and framing the individual pieces so that they will fit when "Raised," or are placed in their permanent position.

LAYING OUT AND WORKING BALLOON FRAMES.

GIRDERS.—Cellar girders to support first floor beams should be laid out to the neat length of the walls, between which they will rest, and have not less than 6" of bearing added on to each end to go into the wall. If the girder be so long that it must be made up of two sticks or timbers, then they must be separately laid out and squared at the abutting ends, and they must be accurately measured with the ten-foot pole, so that the joint will come exactly in the centre of the pier or post, according as the plans and specifications state. It is not usual to halve cellar girders together. But should the specification call for this, then they must be carefully measured to allow for the halving, and still retain the required length from end to end. See Fig. 10. To lay them out they

should be placed on saw-horses at full length and accurately marked and squared with the steel square and lead pencil, and afterwards sawn to the lay out marks. See Fig. 14.

LAYING OUT SILLS.—Sills of balloon frames can be laid out by placing each piece singly on horses, and after determining the neat length to lay out the corners for halving and the spacing of the floor posts and wall studding. The whole length is measured with the ten-foot pole, which should always be used in measuring distances over ten-feet long. The steel square or two-foot rule is applied in laying off the joists or studding, and the corners are marked for halving with the steel square across the grain, and the gauge with it. I would impress upon all carpenters the necessity for placing the two sticks end to end, with the length of the halve overlapping when they are laying out long sills 30' 0" or 49' 0" and to use the ten-foot pole in measuring. This lessens the possibility of mistakes occurring. They might be laid either on the horses or directly on the cellar wall, and I think the latter is preferable, because, if the foundation wall be correctly built to the size called for, the sill must come right; besides, the sills *must* suit the wall.

Supposing, for example, that the side wall of a building is 39 feet, then two 20 foot sticks should be procured and placed side by side on the horses or wall, one overlapping the other 8 inches to form the halved joint, which can be laid out by squaring across the top edges of both at once. This will allow two clear inches on each end for squaring.

Carpenters should take care not to have a straight joint come over a cellar window, as there is always the liability of its coming apart, or sagging down under the weight of the studding above. All sills will in-

variably require to be placed *rounding edge up*.

Sills of hexagonal or octagonal plan are to be laid down according to the plan on the template made for the cellar wall and be halved at the corners.

At Fig. 11 is shown the first floor framing plan of a small house with a bay window, which has the sill 6x8 inch timber, the floor beams being gained into them. If sills are made in two thicknesses

just as the studs and posts will be. This can either be made out of a piece of $\frac{7}{8}$ in. pine or a 2"x4" stud, and it must be laid out for the gain for the girt strip or ribbon and squared at the top and bottom ends. The pattern should be perfectly straight on edge and be out of wind.

When a good pattern is made the posts are first placed on the saw horses and laid out. The ends are also sawed off square and the gain is sawed and chiseled out for

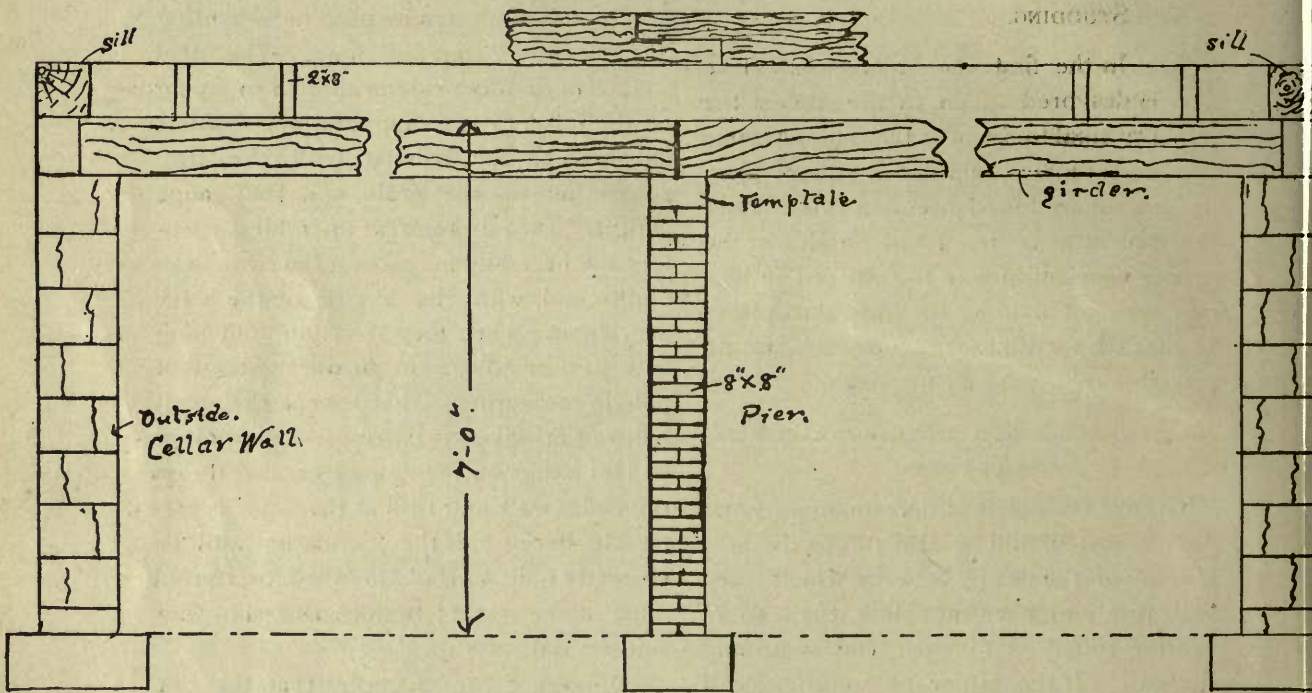

FIG. 10—VIEW OF CELLAR WALL, PIER GIRDER AND SILLS.

of 2 inch plank as is done in some parts of the country, each thickness should overlap, both at the corners and turning points.

POSTS AND STUDDING—Some carpenters and builders form their corner posts in balloon frames of two 2"x4" joists spiked together to make 4"x4" sticks, as it were. Some use 4"x4" scantling, and others make them of one stick of 4"x6." The posts and studding can be laid out from one pattern, which should be first framed

the strip. Next the wall studs are placed on their edges on the saw horses in quantities of 6, 8 or 10 at a time and the edges squared over from the pattern. Careful carpenters use two patterns, placing one each side of a number of joists, when laid on the horses, and then squared across from end to end, or from gain to gain, thus making sure that they will be exactly right. Studding should be laid out on the rounding edge, so that the hollow

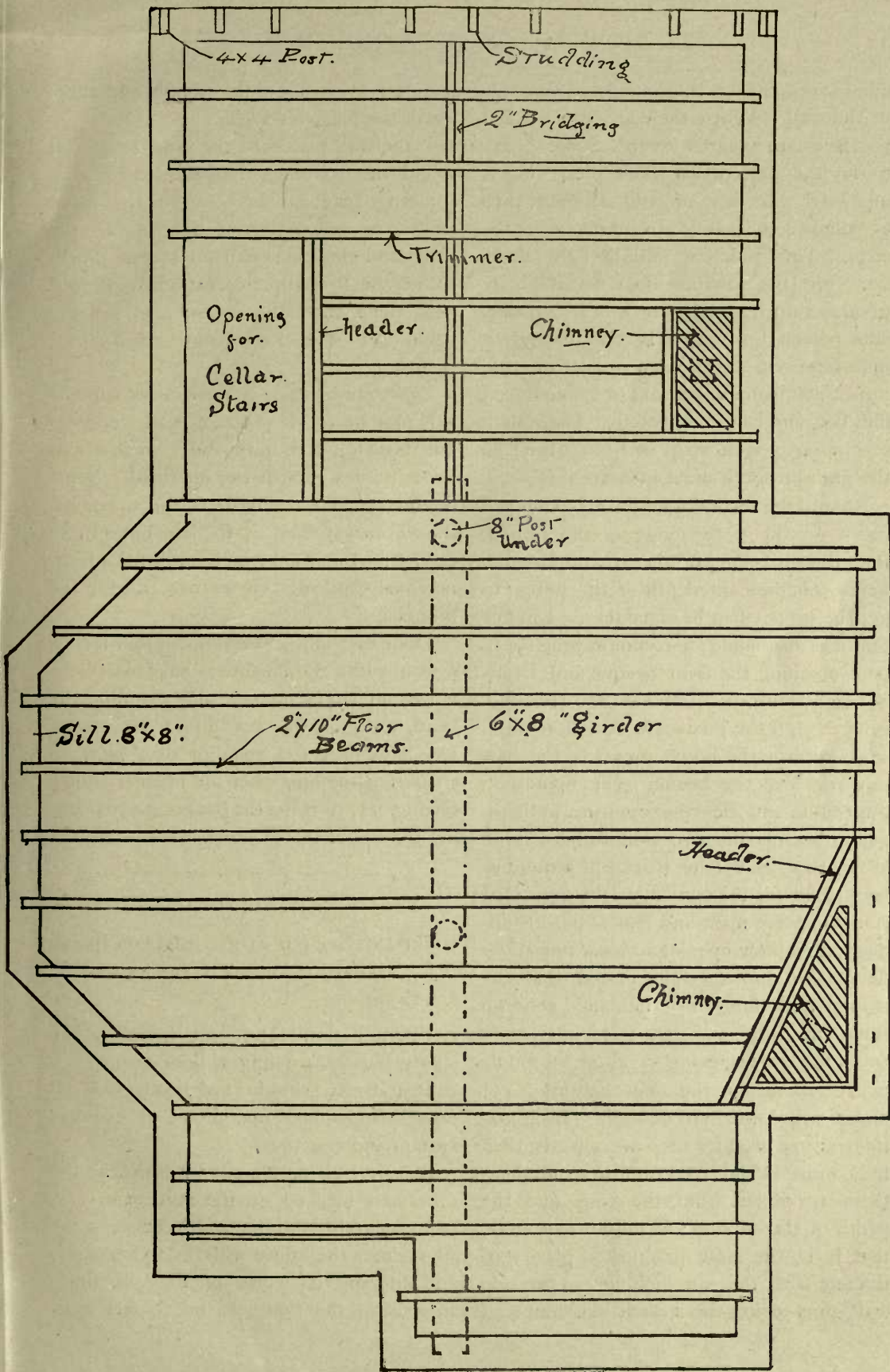

FIG. 11—FLOOR PLAN OF FIRST STORY TIMBERS.

edge will come on the outside or *face* side of the wall. When the edges are marked the faces are squared over. Some prefer to lay the pattern on each piece singly, and mark the face of stud at once, thus avoiding the necessity of squaring over the edge. This practice undoubtedly saves time, but the sawing must be done by good workmen or the joints won't be square. The reason I say this is, that though it may seem very easy to saw a piece of stuff, 2 in. thick, square, without a guide line, I find few who can do it exactly. The ribbon or girt strip is a strip of 1"x6" stuff; so the gain or notch must measure this size.

Should the second floor joists be notched down on the upper edge of the ribbon, then the top edge of the ribbon must be kept up higher, the depth of the notch, to get the proper height of ceiling. I notice that it is becoming a common practice to omit notching the floor beams, and I cannot condemn such omission too strongly, even though the joists are nailed to each stud, because the notch prevents the bottom edges of the beams from slipping on the ribbon and ties the opposite walls together. Only the two side walls or those at right angles to the front will require to be gained for the ribbon, as the floor joist run across the front and rear walls. Studding at window openings *should invariably be doubled* and carefully placed that the casings and siding can be nailed solid on them, at the same time giving room enough in the opening to allow for ample pocket room for the sash weights; 2½ inches will be room enough. If 4"x6" timbers are used for the corner posts, then they must be laid out in pairs, notching them two inches from the edge, and the width of the ribbon; I might say here, that it is the best practice to place 4x6 timbers with the six inch face to the side wall, thus giving the 2 inch difference of

material to nail on the ribbon, and afterwards the plasterer's lath.

If the wall plates be the same height all round the building, then the outside wall studding may all be cut to the same length or one pattern; but should the plans and elevations call for several different heights of wall plates, carpenters should note them carefully, lay out and saw the studding to the exact length required for each height.

Cross studding or *headers* under window sills may be single pieces of wall studding, but those on top, both over window and door frames, are better doubled. Some double the side studding of the openings, the whole way from sill to plate, but a more economical method which might be advantageously followed, is as described in the first chapter.

Door or window openings of four feet or over in width should always have two thicknesses of studding, scantling, forming the head, to resist the pressure from above. Openings of 5 feet span or over *must* be trussed, something after the manner shown on Fig. 11, to resist the beams above bending the upper plates downwards.

CHAPTER IV.

FIRST AND SECOND FLOOR JOISTS OR BEAMS —CEILING JOISTS AND BEAMS AND WALL PLATES.

FIRST FLOOR JOISTS OR BEAMS.—The laying out and framing of floor-beams, is a comparatively simple task, yet, like all other mechanical operations, it requires system and exactness.

A pattern is first made by which all the others are marked, so the student or carpenter should take the width between the sills across the house with the 10 foot pole, and add on the width of the sill, thus: Supposing the house to be 20 feet wide,

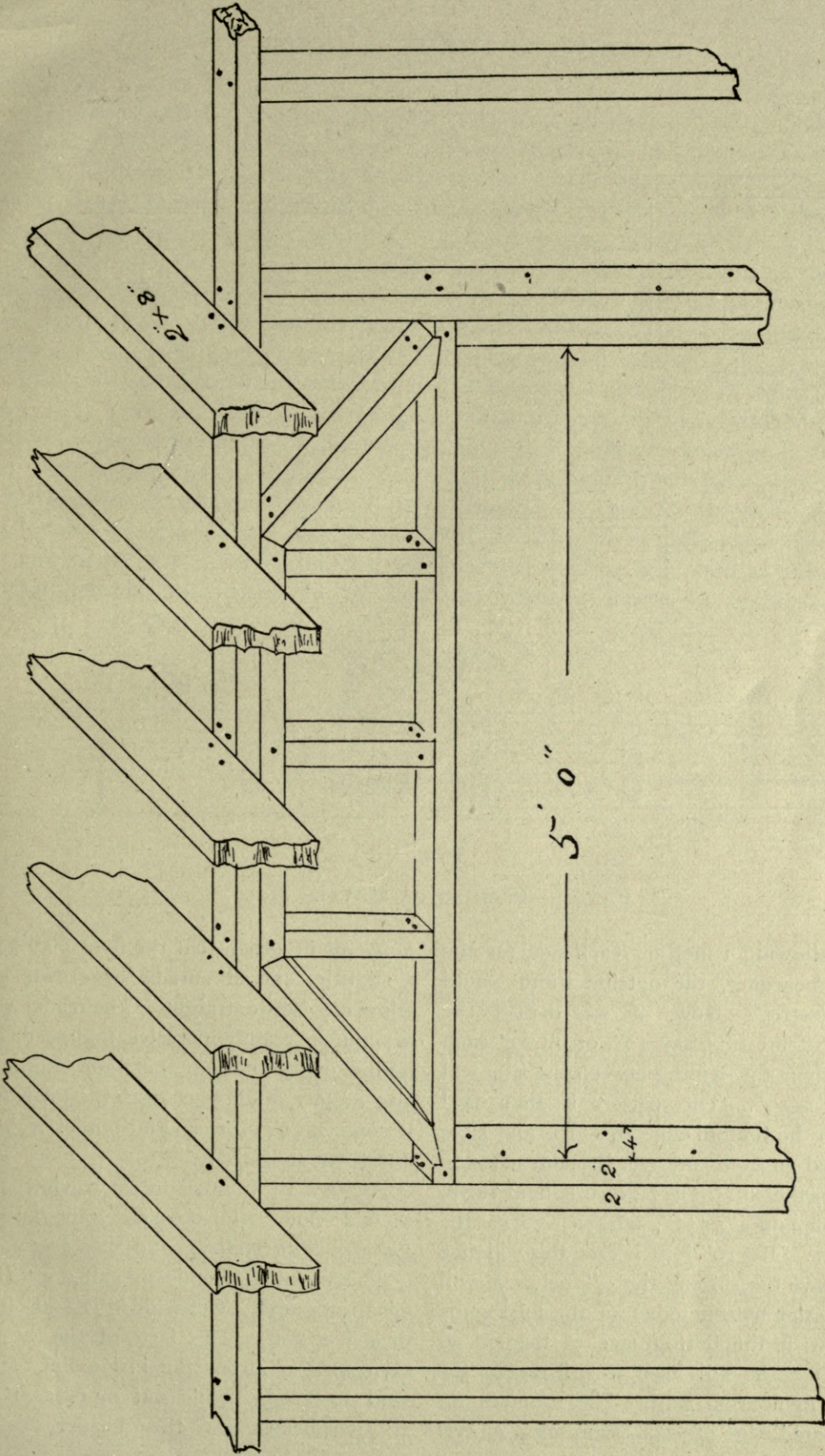

FIG. 12—SHOWING TRUSSING OVER WIDE DOOR OPENING.

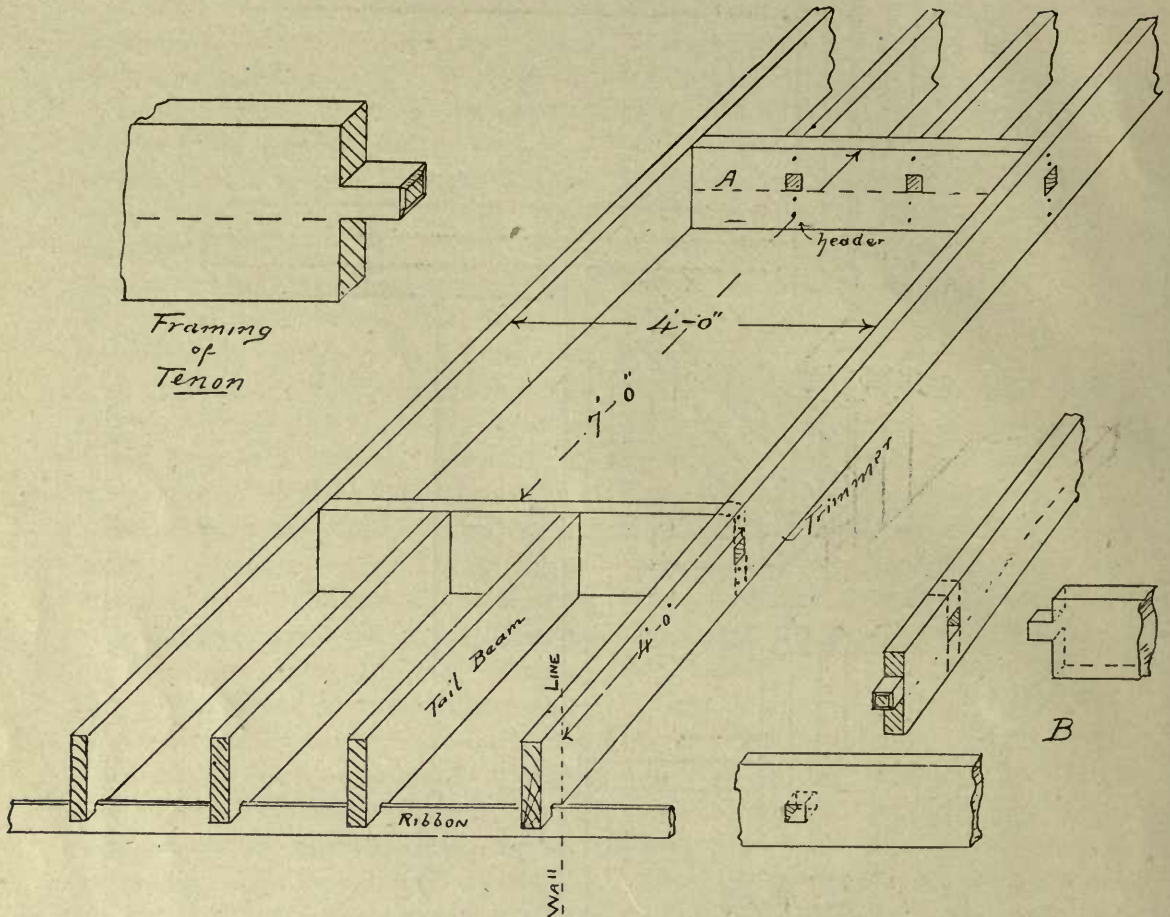

FIG. 13—FRAMING OF A WELL HOLE.

then allowing 1 inch on each side for the rough boarding, the outside width would be 19'-10". Now, if we deduct the width of the sills, say 12", or 6" for each side, then the width between the sills will be 18'-10". The pattern is then laid out on the bottom edge 18'-10" and 5" is allowed on each end over the dimension to rest on the sill. The pattern is next sawn, on each end 4" x 5 1/2", measuring from the bottom. If a 10" joist is used this will give 6" above the sill and the 4" below it will make the bottom edge of the joist come level with the bottom face of the sill, so that like the sill itself it will rest on the cellar foundation wall. The rounding or cambered edge of each beam *must be kept*

to the top in order that the floor may have a slightly curved surface or crown, and allow it to settle straight. The reader will, of course, readily perceive that were the hollow edges kept up the floor would be also hollow, and when it settled it would become much more so and render it both unsightly and unsafe.

At Fig. 13 I have drawn a view of a second floor stair-opening framed with "headers," "trimmers," and "tail beams."

This opening, technically called a "Well hole," measures 4 feet wide by 7'-0" long or 4 ft. x 7 ft. The face of the header comes 4'-0" from the inside line of the wall, so that in laying out mortises in the trimmer-beams for this header 4'-0"

must be measured off from the face of the wall, allowing for the bearing on the sill or ribbon. (I show this framing as for the second story, because the same rule is applicable for the first story.)

From the squared line 7'—0" must be measured off and another line squared over for the face of the opposite header. Back of these lines the mortises must be laid out in the manner represented at B, Fig. 13. A is the neutral axis line or breaking line of the timber. *Every mortise must be made above the line as represented on the stick marked "header," likewise every tenon, as drawn on the tenon framing to the left.* The reason that the framing must be done in this way is, that

this work, the most important thing being care and accuracy in laying out the measurements and framing. The two inch blade of a steel square, and in fact the whole square is most handy in laying out these beams. The method of spiking the joists together is shown by the nail heads.

SECOND FLOOR BEAMS OR JOISTS.—The laying out and framing of the second tier of beams is different from the first, for the reason that they rest on the ribbon or girt strip let into the inside edges of the side wall studding as I described in "Posts and Studding." Their full length will be equal to the full width of the house as below, less $\frac{1}{2}$ " the ends are kept short at each end to keep them back from the outside edges of

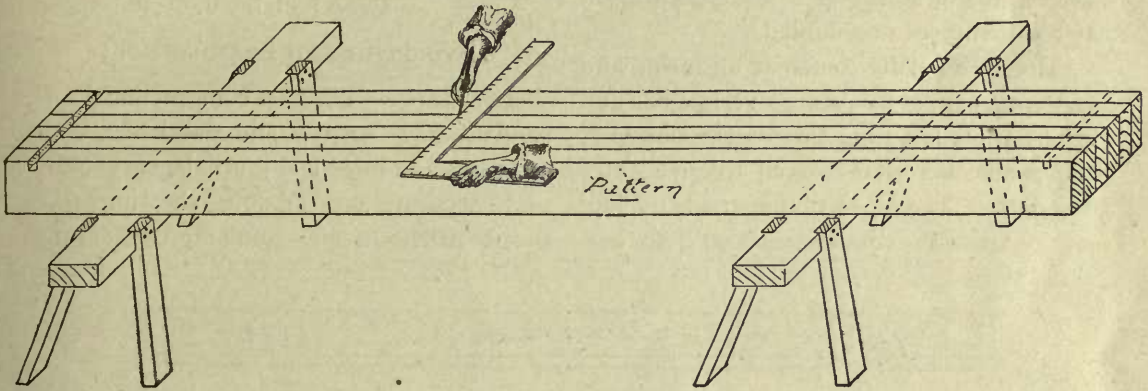

FIG. 14—LAYING OUT BEAMS WITH THE STEEL SQUARE.

the *neutral axis*, or more practically the breaking line of every beam is in the centre of its width, as shown by the dotted line on the face of the far header; therefore all mortises or holes made in beams must be above the line so as to avoid lessening its strength.

At B the student will perceive how the tenon is framed out to fit into the mortise. The tenon is usually the square of the thickness of the stuff or 2"x2". Here also will be seen how the end of a tail beam is framed, in a similar way as the header. There is nothing very difficult in

the studding. The bottom edges are notched on the line of the inside edges of the studding, 1" wide and 1" deep to fit over the upper edges of the ribbon. These beams can also be laid out from a pattern. Fig. 14 shows one gain cut out, also how the steel square is applied and held, when laying out timbers.

One special point which must be noted in connection with laying out floor joists or beams, is to always place the pattern fair with the top or rounding edge of the timber and to mark the notches and gains at an equal distance from this top edge.

This is done to make the top edges all level so that the floor may have a level surface when the beams are placed, and the flooring laid. It would be a safer method to nail a fence on the top edge of the pattern.

CEILING JOISTS AND BEAMS.—These simply rest on the wall plates and will only require to be cut the same length as the floor beams except when the corners on the ends are likely to stick up above the top edges of rafters. Then the corners must be sawn off to leave the rafters clear for boarding.

WALL PLATES.—Except the structures of very large dimensions the wall plates of nearly all balloon frame houses built now are formed of 2"x4" or 2"x6" scantling in two thicknesses or doubled.

They are solidly joined at all inside and outside corners by being overlapped, and where there is a long side on the building, the joints are well broken to give extra strength. The 4" or 6" underside is laid out or spaced across for each stud to cor-

omy, as it saves the over length of studding which would be cut off each gable from the plate to the ridge were the pieces put in from the sill to the rafter. Those wall plates on the gable ends should therefore be laid out, cut and framed before raising, as this tends to hold the walls together.

When the plates are level all round, or rather the walls all the same height, then they will all be set on studding of equal length, but as plans frequently call for plates of different levels and lengths, they must be very carefully studied and measured and clearly understood before the carpenter can lay out a stick of timber.

CHAPTER V.

LAYING OUT AND FRAMING ROOF.

THE ROOF.—The best constructional authorities have written and published, both in books and technical journals, very clear and accurate information, showing the proper methods for obtaining the lengths

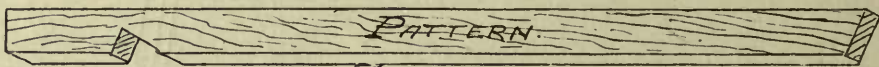

FIG. 15—A PATTEKN RAFTER.

respond with the sill at the bottom so that when the top ends of the whole number of studs are nailed to the spaced marks they will stand *plumb* and *straight*. Some carpenters prefer to lay out the plate from a rod after it is raised. Either of these ways is good, but there are some who would space them out with a two-foot rule as they are being nailed in, a method which I think is very liable to cause an error or get them crooked.

When gables occur on the ends, it is proper to return the plates across them, as at Fig. 8. This is largely done for econ-

of hip and valley rafters, jacks, etc., and as all carpenters should be familiar with some of them they should study the articles on Roof Framing further on. In the meantime I will refrain from touching this subject, and try to show the reader some points hitherto untouched in regard to laying them out.

Rafters should in all cases be marked off by a pattern (See Fig. 15), laid out by a good method to the pitch, which the plan and section denote. The pattern can either be a piece of rafter scantling, or a piece of seven-eighths inch stuff, but it must be

framed *square*, that is, the cuts at the peak and bottom must be sawn perfectly square to the sides. This will give a reversible pattern or one that can be marked from either side or face. It must also have its top edge perfectly straight.

The rule regarding floor beams, about *keeping their rounding or crowning edges uppermost*; also applies to rafters.

There should never be less than two or three inches bearing on the wall plate on the bottom or level cut, in order to permit of a solid nailing into the plate, and thus do

put in position all bearing timbers, *rounding edge up*.

Hip rafters should be backed. I am aware that it is not now customary to do this, still it can be very cheaply done by nailing a beveled strip planed to the angle necessary on the top edge of the hip. This would be a better practice than simply nailing the roof boards on the arises of the hips, as is now done. I would now draw the attention of those carpenters who one day contemplate being builders to a point in roof framing generally unnoticed. It is

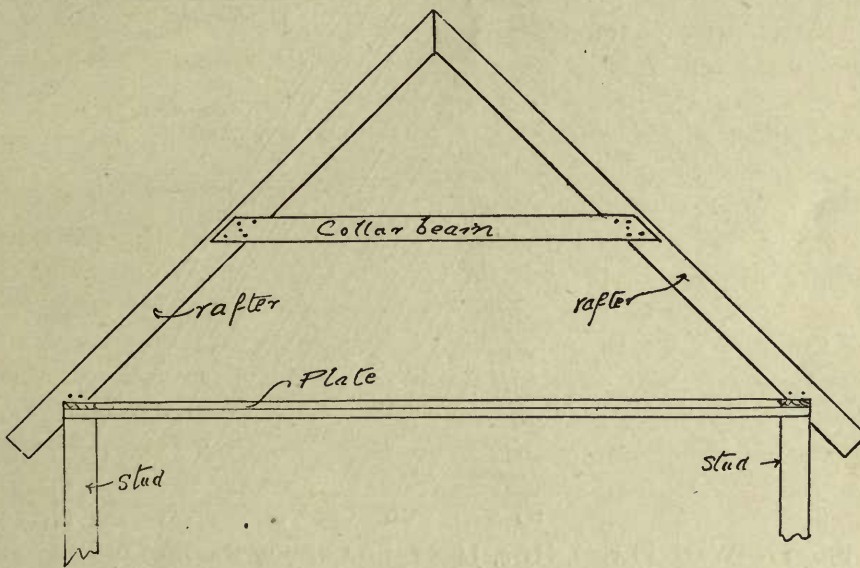

FIG. 16—ELEVATION OF A COLLAR BEAM ROOF.

away with the liability of its slipping off the plate. Fig. 16 is an elevation of rafters with a collar beam, which is inserted to prevent long rafters from bending. This will require to be framed on the ground, and is sometimes halved out to fit under the bottom edges of the rafters or nailed on flat. The measurements should be carefully taken from the plans so as to give the attic head room called for.

Hip and valley rafters will likewise need to be as above; in fact the student should make it a rule to always lay out frame, and

usual to order hip and valley rafters to have them the same width or, more properly, the same depth as the common and jack rafters, and the thickest three inches or one inch thicker than the others. This might not exactly be called an error, but it is scarcely right, which readers will understand on reading the following. Hip and valley rafters are those that form the intersections of the roof planes and they usually have their seats on an angle contained within a right angle. For this reason, then, the top cuts on all jack rafters which fit

against, and nail to, the sides of the hip or valley will be longer or rather deeper than the depth of those they are placed against, and this difference will increase according as the pitch of the roof is increased. It is therefore the duty of every roof framer to see that the hips and valleys are obtained wide enough to receive the whole width of the top cut on the jack rafters and give a solid nailing. To my mind it denotes very poor calculation to see one-third of the cut of the jacks hanging below the bottom

this matter must also be attended to in regard to ridges, which should, in all cases, be at least equal in width to the top cut of the common rafters which abut against it. They should be perfectly straight or slightly crowning on the top edge, but never hollow. They should also be laid out on one side with the spacing of the rafters. Fig. 17 will give the student a clearer understanding of what is written above, as it shows a projected view of the hips, ridge jacks, rafters and plates. When

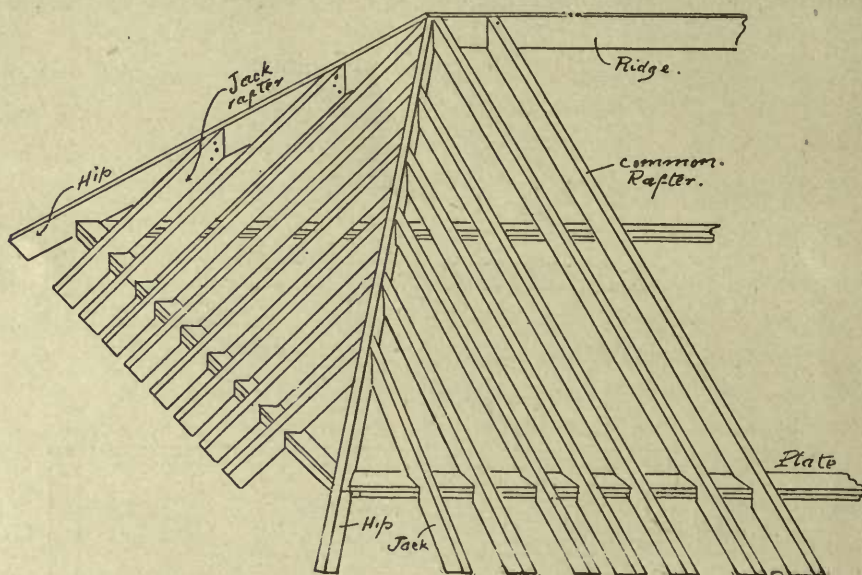

FIG. 17—WALL PLATES, HIPS, JACKS AND COMMON RAFTERS IN POSITION.

edge of the hip rafter, and I have known architects who have compelled builders to remove the insufficient timbers and to replace them with others of adequate proportions.

I know there are some who will argue that the hip will be sufficiently strong supported by two sets of jacks without being particular about the joints. To these I would answer that the hip supports two planes and that half or two-thirds of a joint is only half or two-thirds as good as a whole joint. For roofs over one-third pitch the angle rafter should therefore be deepened ;

very long ridges are inserted, necessitating two pieces, end to end, to make up the whole length, the joint should be placed in the space between two rafters to allow a cleat or tie piece to be screwed or nailed across it to hold the pieces strongly together. Another important point is to lay out the ridge that the rafters will abut against each other, and not at one side or other which would tend to bend the ridge after the rafters are placed in position. They may either be one-inch or two-inch stuff, as desired, but on light frame dwellings one-inch stuff will be suitable.

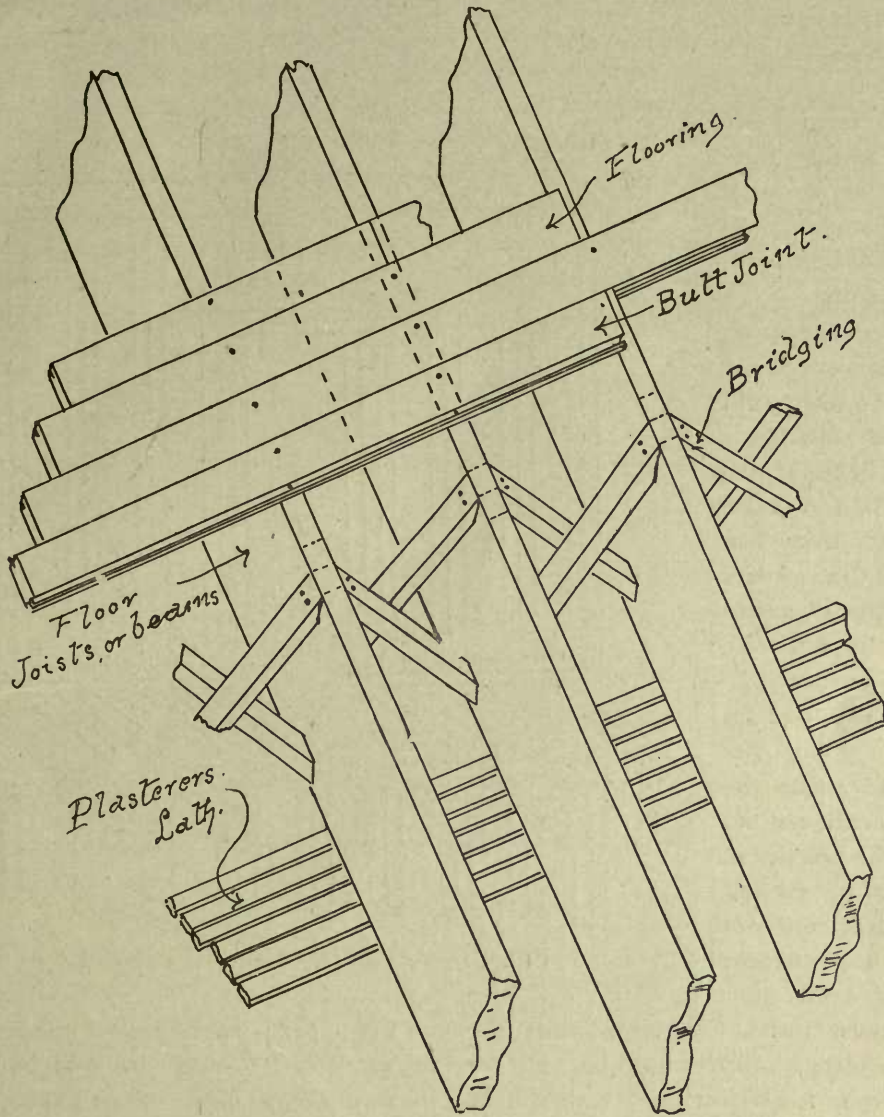

FIG. 18—PROJECTION OF A BALLOON FRAME FLOOR.

CHAPTER VI.

RAISING.

There is no part of the construction of a frame building which requires more care or accuracy than the raising of the frame. I therefore trust that my remarks on this subject will be carefully read, as they will be found very applicable in practice.

PLACING CELLAR GIRDERS.—These will require to be lifted into the place on top of

the piers built for them in the cellar, or set perfectly level and straight from end to end. Some prefer to give their girders a slight crown of say 1 inch in the entire length, and it is a wise plan, because the piers generally settle more than the outside walls. When there are posts instead of brick piers used to support the girder, the best method is to temporarily sustain the girder by uprights made of pieces of 2x4 joists resting on blocks on the ground below. When

the superstructure is raised these can be knocked out and the permanent posts placed, resting their bottom ends on a broad flat stone, to form a base or foundation footing.

If the supporting posts and piers be not placed or built until after the building is erected, then carpenters should exercise good judgment when jacking the girders up, to place them under it and not raise them so much as to strain the building, and it is always desirable to obtain the crown mentioned before. The practice of temporarily shoring the girders, and not placing the permanent supports until after the superstructure is finished, is favored by

good builders, and it would be well for carpenters to know just how it should be done.

SETTING THE SILL.—After the girder is in position, the sills are placed on top of the cellar walls, rounding side up and hollow side out, and are very carefully fitted together at the joints and leveled throughout. The last operation can either be done by a sight level or by following the simple method I am now about to describe.

Place $\frac{7}{8}$ inch blocks at intervening distances on the length of each side, also one at either end, and set a long parallel straight-edge on them, also set a true level

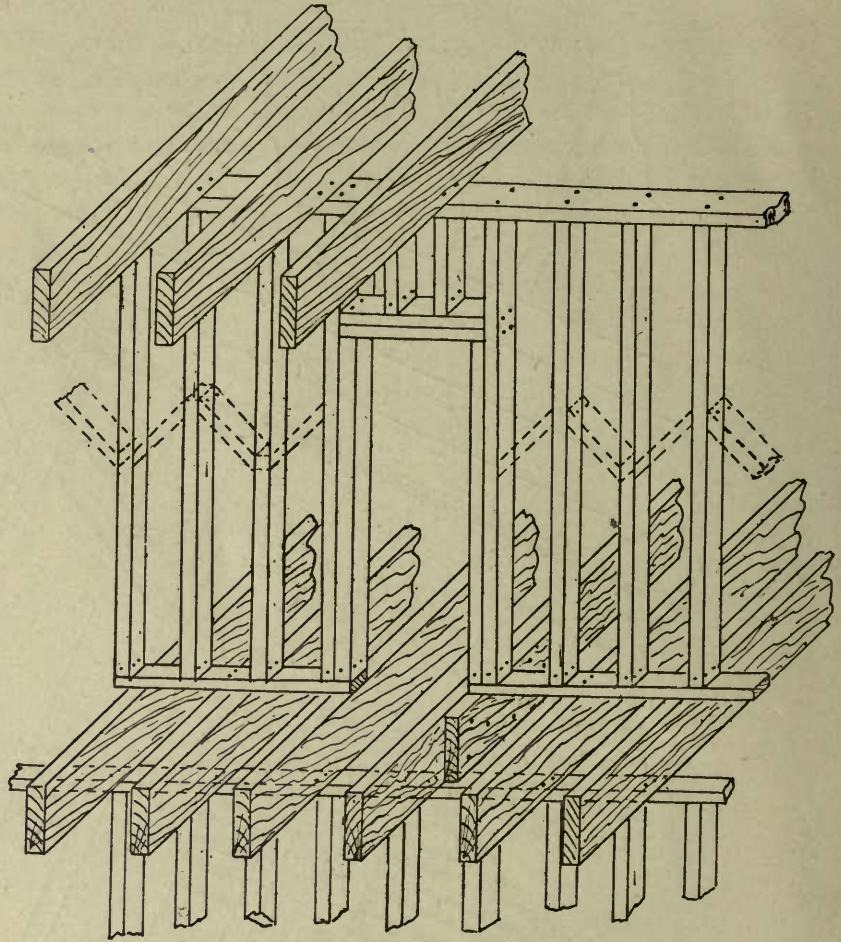

FIG. 19—A FRAMED INSIDE PARTITION.

on the upper jointed edge of the straight-edge. The sill must be wedged up, or lowered down until the air bubble in the level tube is exactly in the centre, and each piece must also be wedged up or lowered till the blocks all touch the bottom edge of the straight-edge. In all cases the whole length of the sill should bear solidly on the stonework, and it should either be bedded in mortar or made solid with chip pieces of slate, stone wedges or furrings, and these should not be inserted less than two feet apart.

Sills are generally kept back $\frac{7}{8}$ or 1 inch from the face of the stonework, to make the sheathing come flush with it, and

allow the water table to project the thickness of itself (usually 1 1-3 or 1 3/8 inch) to keep the water off the stone.

Sills must be taken out of wind, that is to say, they must be level all round, so that when the carpenter sights them across with his eye (the other being closed), the surfaces will show as one line.

All sill joists will require to be toe-nailed or spiked to draw them closer together,

SETTING FIRST FLOOR BEAMS.—This important job is done by experienced carpenters in the following manner:

The stairs and chimneys being conductors, or rather passing up from one floor to the next one above, and having timbers framed to form the openings, or, as they are technically called, "wells," the header and trimmer beams round them must be placed first. The proper method to follow

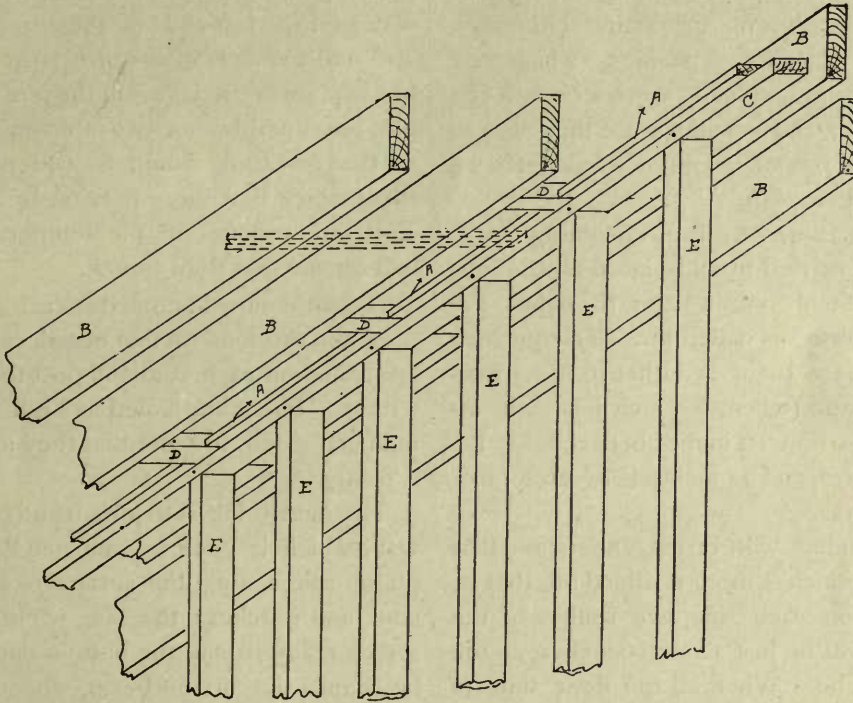

FIG. 20—FRAMING OF A PARTITION BETWEEN BEAMS.

and the running joints should be nailed dovetail fashion. When sills are made up of two thicknesses of plank, as they sometimes are, they will need to be solidly spiked together, to form one, with dovetailed nails.

As some of my readers may not clearly understand what is meant by "dovetailing" nails, I will here state that a carpenter dovetails nails when he drives two with the points inclining to or from each other, so that they form, as it were, a "dovetail."

then is, to place and nail one trimmer beam first, exactly in position on the sill, and then to insert its fellow opposite it, loose. When this is done the framed header may have its tenons placed in the mortises in the pair of trimmers, and the loose trimmer made parallel to the one that is nailed, that is, it must be the same distance apart at the sill end as the length of the header. When two headers are framed in, then it will only be necessary to straighten the trimmers from end to end. The trimmers will like-

wise require to be set square to the sills. After the headers are set, they and the trimmers should be solidly spiked together, keeping the headers square with the trimmers.

The "tail" beams or joists are next placed, the framed ends, with the tenons, being slipped into the mortises in the header, and there solidly spiked to keep them in place.

This practice of first placing all trimmer and header beams for stairs, chimneys, hearths, or other openings which are framed around, should always be adhered to, because the openings are then sure to be in their proper position as denoted on the first floor plan.

Having these set, the remaining single joists are carried in and placed on the sills, spacing them out at 12 or 16 inches between centres, as called for. The quickest way to space them is either to use a two-foot rule and (when two inch joists are inserted) to allow 10 inches between for 12-inch centres, and 14 inches between for 16-inch centres.

The student will, I trust, understand that when two inches more is added on, that is, one inch on each side, the centres of the timbers will be just 12 or 16 inches, as the case may be. When all the floor timbers are in and toenailed to the sills, a strip is nailed across the top edges to keep them from being overturned. This strip should be kept back at least 12 inches from the end, in order that it may not interfere with the wall posts or studding when raising.

A temporary floor must now be laid on the beams, by placing sheathing board across them, and they should be so placed that there may be no traps in the floor. By traps, is meant the ends of the boards which project over one beam and do not rest on the next, so that when a man stands on the end it is a trap which, being pressed

downwards by his weight, lets him fall between the beams. In every case the end of each board should rest on a joist or beam to prevent this occurring. Fig. 18 represents a section of a balloon frame floor with the bridging in position, also the lath and flooring.

RAISING THE OUTSIDE WALLS.—This, the next operation, is performed very simply. If the wall be not too long, or not more than 25 feet, proceed to spike the wall plates on the top ends of the corner posts, also nail the ends of the girt strip, or ribbon, square in the jambs in the posts. Next place and nail one or two intervening studs on the plate and ribbon, to the marks on them which have been previously laid out. This can be done on the temporary floor laid on the first floor beams.

A man is now stationed at each stud and post, and the construction raised, and braces are nailed on each stud and post to prevent falling. These are nailed as high up as a man can reach, in order that they may hold it firmly.

The next thing is to plumb and brace the wall, which is done by one man holding a plumb rule against the surface of a post or stud and watching the bob, while another stands ready to nail the bottom end of the brace into the sill or beam, whenever the bob indicates that it is exactly perpendicular. The rule must be applied to both sides of the posts, to insure their being plumb both ways, and two braces will be needed, or one on each of the sills which form a corner.

If the wall plate be laid out the same length as the sill, then plumbing one post will plumb both, that is for one wall, but both posts must be plumbed separately for the end walls.

Supposing the side walls to be raised, the intervening studding may be inserted, but where window and door openings

occur the studding on each side of them must be doubled. This may be done either by putting them in full length reaching from sill to plate, or by placing single studs full length, and after nailing in the cross headers to cut in cripple studs the length of the window opening. For the sake of economy the last method is most popular. The side studs, forming openings, must likewise be plumbed.

Where there are stretches of wall between windows and doors over four feet in length, the studding will need to be spaced 16 inches between

centres, or 16 inches from the inside of one stud to the outside of the next, which, it will readily be understood, is the same thing. Carpenters call this spacing from "in to out," and follow it for joists, studding and rafters.

If the intended house will be situated in a locality where it may be exposed to much strain, through heavy wind pressure, it would be well to cut in an angular brace, abutting against the corner post, under the ribbon,

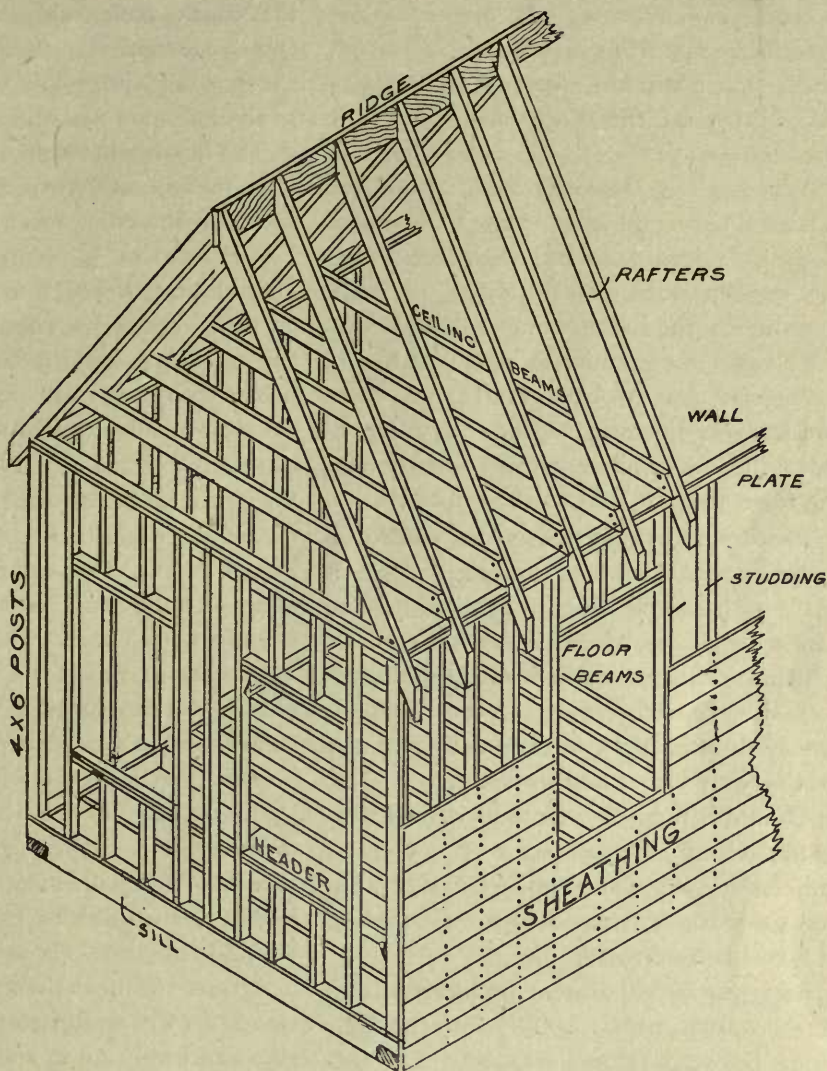

FIG. 21 Illustrates the frame of a small framed cottage, of one story, with the ceiling beams and rafters raised, and one side partly sheeted or rough boarded. Upper headers are doubled in windows.

and fitted down on the sill abutting against a window stud. This will stiffen the frame, and is a practice largely followed along the Atlantic coast, where the dwellings are frequently subject to the pressure of heavy gales. See Fig. 7.

Another thing, always essential, is to properly truss over window and door openings, which can either be spanned by a 4x6-inch timber, or the weight above can be carried over to the studs by angle

braces. In any case, where four or five studding, supporting a plate and timbers, occur over a window, precaution should be taken to resist the downward pressure in the above way.

When the sidewalls are raised and braced, the second floor or tier of beams or joists are raised and fixed in position, resting on the ribbon, and holding the walls together by the notch which I described in the chapter on Framing. It is best to nail each joist against each wall stud when possible, as it enables the carpenter to make the construction more solid by nailing them to each stud as they occur.

The second floor beams are placed on the ribbon in a similar manner, being set so that the notch or gain in their bottom edges drops on the edge of the ribbon. All those beams which come against studs should be spiked solidly thereto. A temporary floor is laid as below to enable the men to walk about and work on.

The third floor or attic timbers must rest upon the wall plate, and can be set either before the walls are sheathed or after, but it is usual to set them before commencing to board the sides.

Bridging should always be inserted and the top ends nailed solidly into the floor beams before the floors are laid. The bottom ends can be nailed after they are laid, thus stiffening and raising up the floor. The writer prefers to nail the bridging top and bottom before laying the flooring, thus preventing sagging under the super-added weight of the floor, and he condemns the practice of laying the floor before the partitions are set. Herewith are presented two sketches showing the proper way to construct and bridge inside partitions. Fig. 19 is where the partition crosses the beams at right angles and Fig. 20 where it runs in the same direction as the beams. It will be noticed in the latter

that blocks have to be set up to receive the top piece and that a strip is nailed on the top of the plate to which the ends of the laths are nailed for plastering

The heights between the floors are usually taken with two rods, sliding them apart till the ends meet floor and ceiling. Not more than $\frac{1}{4}$ of an inch over length should be allowed, and measurements for partition studding should be taken with the top plate on the bottom plate, measuring with the rods up. Partition lines should be laid down with a chalk line.

RAISING THE ROOF.—When the top floor or attic beams are placed, the temporary floor described above must be laid across them. This can be made up of the boards to be used in covering the roof, usually of spruce or hemlock. A peak scaffold must next be constructed, formed out of two uprights, 2 x 4 studding, and bearers and braces of strips or boards. The height can be taken with a ten-foot pole, by measuring off the height from the floor to the ridge, and then deducting the height of a man who will stand on it; thus, if the height to the peak be twelve feet, then the scaffold should be about six feet high. It need not be more than three feet wide, or two boards in width, so that one man may stand and walk on it, and it should be well braced. When the scaffold is ready the rafters may be raised in the following manner:

Commencing at the gable end, a pair of rafters one on each side of the ridge are set up, with their top cuts abutting, and the bottoms on the plates may be nailed solidly to each plate. Another pair are set up similarly on the other gable, or near the valley if there be one on the roof. The ridge is next lifted up and set in between the peak cuts, and there solidly nailed. These can now be braced by nailing on a board reaching from the rafter on the gable

to the plate. This will be enough at first. The intervening rafters, spaced sixteen inches or twelve inches on centres, as desired, set up in place, care being taken to keep the ridge straight in nailing. Hips, valleys and jacks are next set up and the whole roof well braced diagonally with several boards to prevent it being overturned by the wind.

Collar beams may be inserted either before or after the roof is covered, but the

pitched down and out about half an inch in every twelve inches, in order that the joints of the flooring may be in the line of the water running off the house. This will give three inches pitch in a 6-foot porch, enough to keep it always dry and prevent rot. Porch floor beams should either rest on brick piers or good posts, and have sufficient footing to prevent settlement.

Some builders set inside partitions at the same time as the outside walls, before covering in, but this hinders free movement on the floor when working, handling timbers, etc. Inside partitions should always be set first on the first floor, and then on the second floor, and so on up, thus maintaining the levelness of each. Great care must be exercised to have all door and window studs perfectly plumb, and headers perfectly level.

All nailing should be done without splitting the timber, nor should the hammer head be driven into the wood any more than necessary. This should be especially guarded against in toenailing, as too often the end of the rafter, stud, etc., is broken off and the nails have no hold whatever.

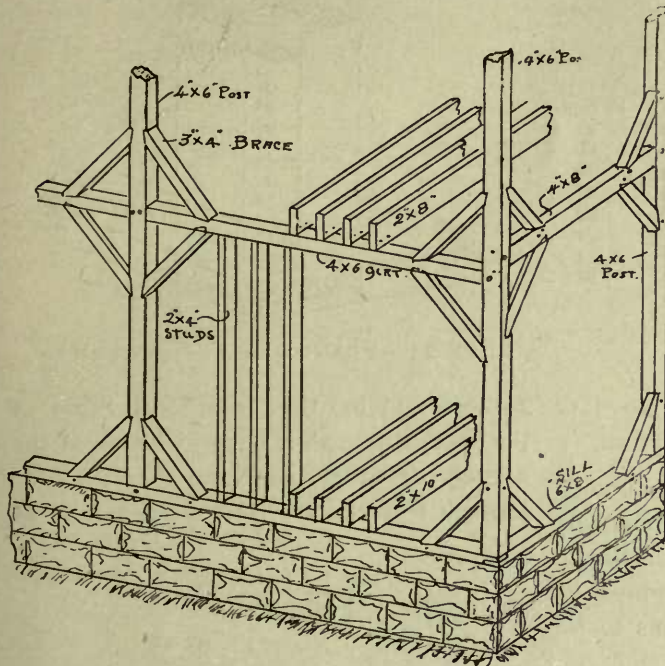

FIG. 22—PERSPECTIVE VIEW OF A BRACED FRAME.

safest method is to cut and nail them in before the roof boards are nailed on.

The projecting ends of the attic floor beams are now sawed off and the roof is ready for cornice and covering.

Much the same rule will apply to the framing of porches and piazzas with their roofs; that is, the plate is nailed on first, then the beams, the floor is next laid and the posts and roof are then set up.

Porch and piazza floor beams should be laid parallel to the front of the house and

Long beams, hips and valley rafters must be kept straight from end to end by sighting them through with the eye, likewise all long studding. This is essential for the reason that the spacing must be accurate for the plasterer's lath, flooring, boarding, etc.

Balloon framed houses are a better job when sheathed or boarded diagonally. It is a little more expensive in the labor, but stiffens the whole construction.

Thirty and twenty-penny spikes, and

ten-penny cut nails or wire nails are the best for nailing together the timbers of balloon framed houses.

A ladder for climbing floors can be readily made up of two sound 2"x4" joists and 7/8"x2" cleats or strips nailed on the edges of the joists with eight-penny nails. Steps to be spaced 12 inches apart.

NAILS FOR FLOORING AND ROOFING.

The following table will give carpenters the proper size of nails to order for any job. The table is for ordinary widths from 3-inch to 7-inch boards :

Thickness of floor.	TABLE. Size.	Length.	No. to pound.
7/8 inch	8 penny	2 1/2 inches	92
1 1/4 inches	10-penny	3 inches	60
1 3/8 inches	12-penny	3 1/4 inches	44
1 3/4 inches	16-penny	3 3/4 inches	32
2 inches	16-penny	3 3/4 inches	32
2 1/4 inches	20-penny	4 inches	24
2 3/4 inches	20-penny	4 inches	24
2 3/4 inches	20-penny	4 inches	24

CHAPTER VII.

BRACED FRAME HOUSES—HOW TO LAY OUT, FRAME AND CONSTRUCT THEM.

Frame houses constructed on the braced system differ from those of the balloon type in the fact that the timbers with which the whole frame is made up are framed or mortised and tenoned together so as to be solidly and securely fastened.

In this respect houses constructed in this manner differ from those constructed on the balloon principle as in the latter the pieces are simply held together by nails while in the former they are mortised, tenoned and pinned. Braced frames are the best constructed for frame houses. By reason of its great expense this system is not so popular as the balloon principle, yet as it is sometimes adopted in good or large work every carpenter should have a knowledge of it.

Fig. 22 is a skeleton or perspective view of the side walls of a braced frame house

and the parts are of the following sizes and thus framed: The sill, generally a 4x6" or 6x8" timber is halved together at the

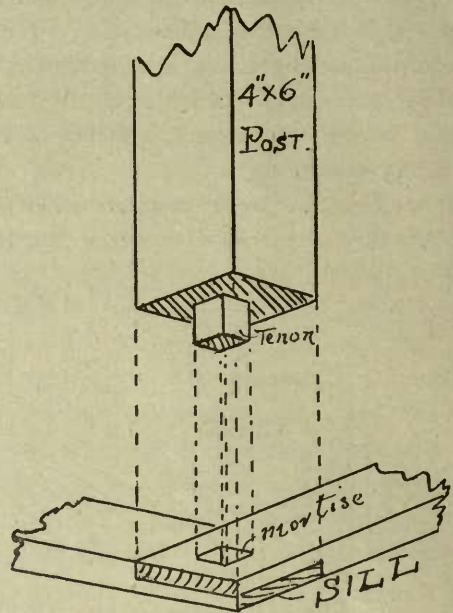

FIG. 23—FRAMING OF POST AND SILL.

corners and mortised out, for the foot of the posts where they occur, whether at the corners or other places on the sill. Intermediate posts are often draw pinned as

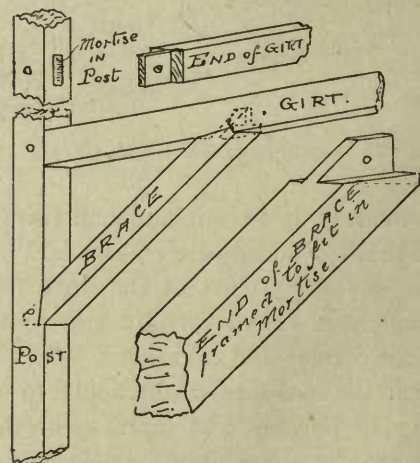

FIG. 24—FRAMING OF GIRT AND BRACE.

shown in the engraving, but this is scarcely necessary as the weight of the post is in itself sufficient to keep the tenon in the

mortise. Fig. 23 will give a clear conception of the method of framing the foot of a post into the sill. The tenon is about 2 inches square and 2 inches deep and the mortise is the same size, 2½ inches deep. The principal object of the tenon is to prevent the post slipping off the sill.

Referring again to Fig. 22 it will be seen

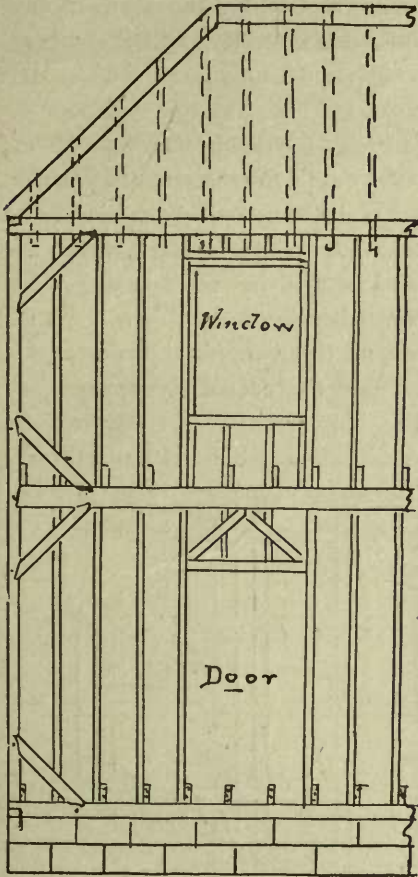

FIG. 25—SIDE VIEW OF BRACED FRAME.

that the first floor beams rest on the sill being supported in the centre of the width of the house by a girder or heavy timber 6x10" or 8x12" according to the width. These first floor beams are usually 2x10" or 2x8" timber and either rest directly on the sill or are halved out to rest on both sill and stonework of foundation. Here I have for simplicity drawn them resting entirely on the sill.

The second floor beams are supported by a timber termed "a girt" or intertie, which is mortised and tenoned into the post in the manner shown at Fig. 24, on the top of the engraving. Here also will be seen

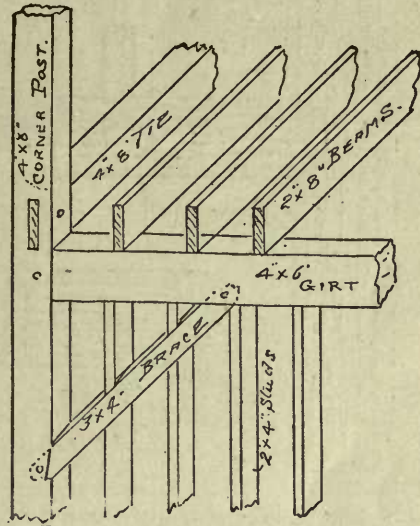

FIG. 26.

the method of framing the end of the braces into the posts, sills, girts, wall plates, etc., in order to obtain a rigid construction. The mortise is cut in square but by reason

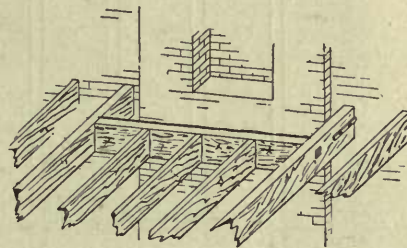

FIG. 27.

of the brace being on the angle it is necessary that one side be on the angle as shown and the gain to receive the thrust of the brace will require to be set on in the way represented above the dotted line in the enlarged engraving of the framed end of the brace.

All posts, girts and braces and plates are draw-bored after being framed to receive

the pins. An inch auger bit is generally used.

By "draw-boring" is meant that the hole

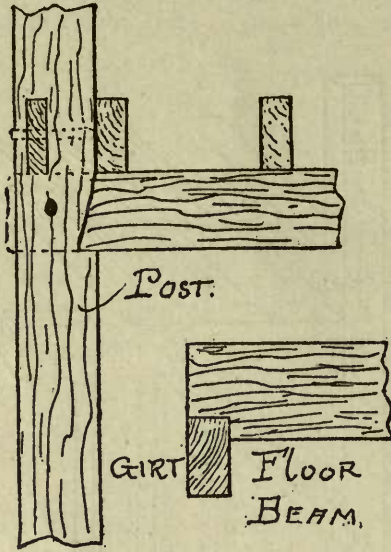

in the tenon is generally nearer to the shoulder of the piece tenoned than the hole

in the mortise, in order that the taper pin may draw the shoulder closely up against the piece which has the mortise. Pins should be 1 inch diameter and made of oak for a spruce or yellow pine frame.

Studding in braced frames is sometimes tenoned into mortises in sill plates, girts, etc., but the time it costs to pursue this method is fast doing away with it and they are nowadays mostly cut in "barefoot" or without tenons, having only a squared butt end.

At Fig. 25 will be seen a side view of a braced frame showing the main parts as at Fig. 22, also the studding set at the frame round a door and window, the plates set on, and part of the roof raised.

The plates are 4x4" stiff halved together at the corners and mortised on the under side to receive the top ends of the posts. The positions of the timbers will be readily comprehended from the engraving.

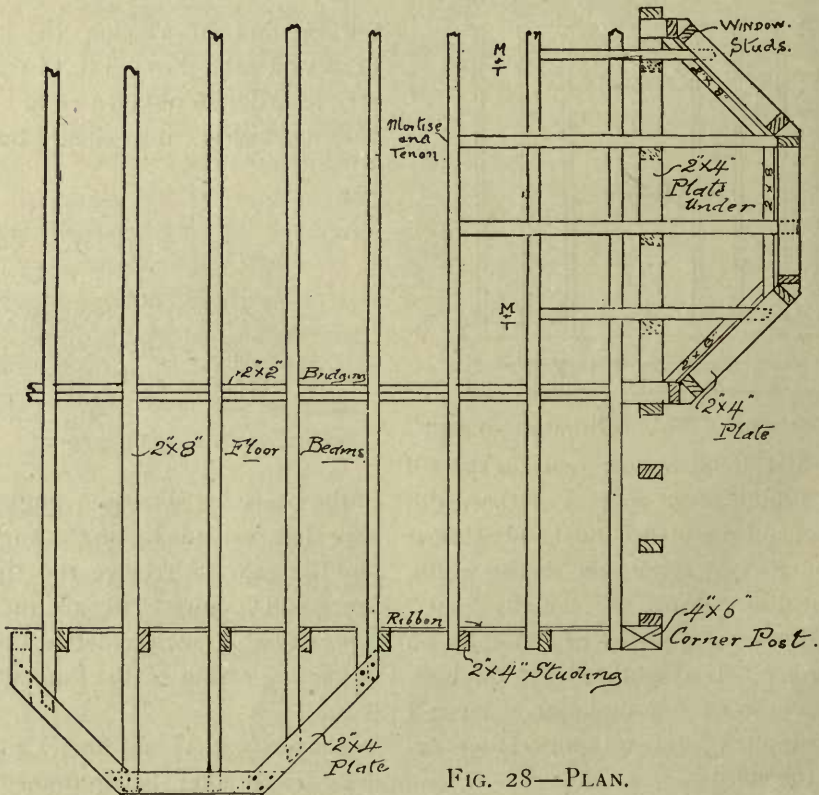

FIG. 28—PLAN.

ings, Figs. 25 and 26, as they are very clear, and by a comparison with Fig. 22 will be easily reproduced in actual work.

When laying out braced frames care should be taken to lay out and frame all the sills, posts, girts, braces, studs, plates, etc., the exact length; they should also be very carefully mortised, tenoned and fitted together before the pairing. When framing the post the mortises for the girts must be placed one underneath the other. Fig. 26, being an enlarged view of the framing, will illustrate how this is done and it will be seen in some of the preceding engravings. It will also be noticed that the shoulder of the girt is gained into the post. This is often done in high class work though it is scarcely necessary, because the square shoulder with the braces and studding under any girt is sufficiently strong without gaining it in.

I cannot lay too much stress on the necessity for very carefully measuring all the pieces, especially the braces, which may either be laid down to scale, or full size, or laid out with the steel square.

When raising, the cellar girders and sills are first set on the stone foundation, then the sides are set up, the posts being first placed and braced with boards, then the side girts are inserted in the mortises and pinned; the end girts come next and after this the studding on first story (if cut in bare-foot). If not, the whole side framing, sill, girt, and all may be put together, pinned and raised as one "bent" or piece of framing. The wall plates and second story studding may be set up after the second floor beams are set and a temporary floor laid on them to walk on.

Fig. 27 will show the method to be followed in framing round a chimney breast, with a header, tail beams and trimmers.

In the foregoing engraving readers will obtain full information in regard to the

manner of placing a framing together, posts and girts in barn or other heavy framing, so as to obtain great strength.

CHAPTER VIII.

HOW TO FRAME OUT A BAY WINDOW ON THE FIRST OR SECOND STORIES.

This is a problem in the construction of frame dwellings which sometimes occurs and taxes the ingenuity of many carpenters, so in this chapter I am pleased to offer some explanation of the methods of doing it.

Usually, bay windows, either of square or octagonal plan, are on the first story, built with the rest of the frame, and having the sill resting on a stone or brick foundation, the sill being on a level with the main sill of the house.

Sometimes this does not occur and the architect may either frame out a bay window on the first story or place it on the second story. Often two windows are introduced, as will be seen by referring to the illustrations.

As to the methods of framing out these windows I have shown two at Fig. 28. On the front or right side the bay window demands special framing; because it cannot be supported on the floor beams or joists in the way by which the side window is obtained. On the side the floor timbers are simply allowed to project out beyond the face of the wall, the projection necessary to support the octagonal form shown, and the plate upon which rests the window studs necessary for the bay are nailed on top of them. The plan, Fig. 28, will give the readers a clear conception of this construction.

For the window on the front a very different form of framing prevails. Here the

fact that the bay must be supported by floor beams at right angles to the regular floor beams of the house compels the carpenter to use his ingenuity in supporting the window safely, and I therefore put forward illustrated to the right of the plan, Fig. 28 and the elevation Fig. 29. The principle adopted is that of cantilever and is simple in construction and quickly framed.

tised and tenoned into the second beam from the wall and that the second beam is mortised and tenoned into the central beam on each opposite side, by this means forming a perfect counter-poise. Short pieces of beam stuff are cut in between the supporting beams, on which to nail the flooring, also on the angle of the bays. The mitre cuts of the octagon may be found by

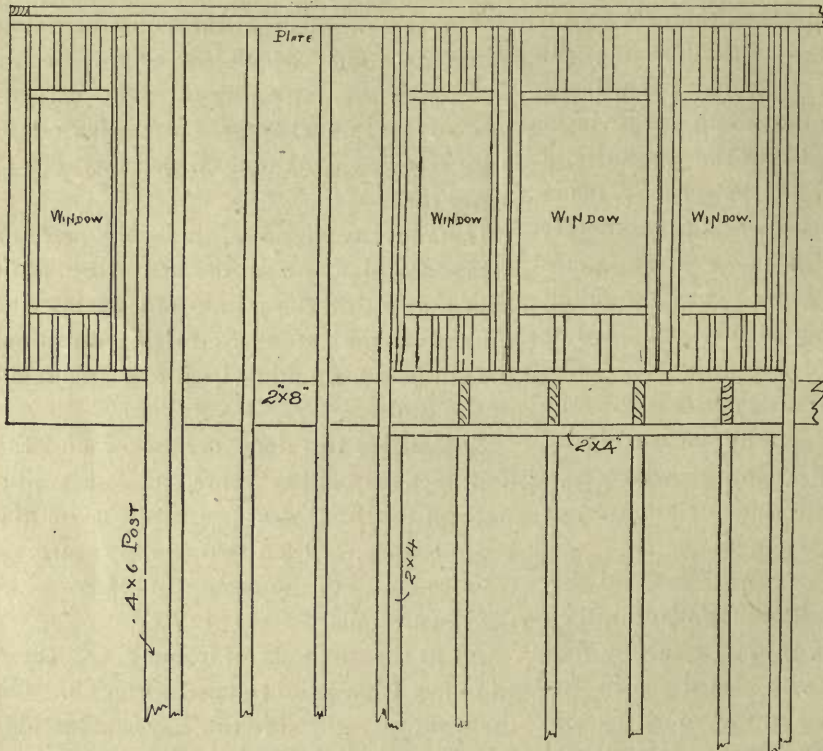

FIG. 29—ELEVATION.

It will be noticed, then, that the two central supporting beams rest on a plate placed under them which is in turn directly carried by the first story wall studding, and that they are mortised and tenoned into one of the floor beams (the third from the wall), thus making the floor beams *balance*, as it were, the weight of the bay window timbers resting on it outside the face of the wall. In a similar manner the two outside projecting and supporting beams are mor-

using the figures 7 and 17 on the steel square or by any of the simple methods in everyday use.

Some framers prefer to double up the third or fourth floor timber and frame all the supporting timbers into them, but I am opposed to this plan as so much mortising weakens the beam and does not distribute the strains.

The following figures are used in order to find mitres on the steel square for laying out bay windows:

12"	and 12	=Square Mitre, or 45°
7	" 4	=Triangle " " equilateral
13¾	" 10	=Pentagon " " 5-sided fig.
4	" 7	=Hexagon " " 6 " "
12½	" 6	=Heptagon " " 7 " "
18	" 7½	=Octagon " " 8 " "
22½	" 9	=Nonagon " " 9 " "
9½	" 3	=Decagon " " 10 " "

SHEATHING.—As soon as the exterior studs are in position, the building should be sheathed with inch boards nailed diagon-

ally so as to give additional bracing to the studs.

The roof should be sheathed with $1\frac{1}{4}$ inch boards to allow a better hold for the shingle or slate nails.

SHINGLING.—When the cornice is set and the gutters on, the roof is sheathed, the valleys should be tinned and the flashings put around the chimneys, the tin being first carefully painted on both sides. The roof, with the exception of the valleys, is also often covered with felt or tarred paper, and the shingles are then put on, commencing at the eaves. Each shingle should be laid with three laps, according to the weather, 5, 6 or 7 inches as may be required, and each should be nailed with two galvanized iron nails, one on each edge.

CLAPBOARDING.—When the roof is completed the window and door frames are inserted, and the casings or architraves nailed on. The building is then covered with prepared paper and is ready for clapboarding.

Before commencing to put on the clapboards, the water table is put in place, and it should lap $1\frac{1}{2}$ inches over the foundation wall on its lower edge, and be cut on its upper edge so as to allow the clapboards to form a tight joint.

The clapboards are usually $\frac{1}{2}$ inch thick, the width varying from 5 to 6 inches. The clapboards should lap one inch.

Care must be taken to have a tight joint between the clapboards and the door and window casings. Strips of zinc are sometimes laid at junction of clapboards and casings, and this is particularly desirable at the top of a casing.

GENERAL HINTS.—If wooden posts are used to support a girder in a cellar, they should rest on a stone at least 8 inches above the cellar floor, otherwise the lower end is liable to rot. Cast iron columns are better than wooden posts; brick piers are best.

The sill being near the ground, and usually resting on a wall of masonry, which attracts moisture, is liable to rot. Care should therefore be taken to have the top of the foundation wall at least 18 inches above the surface of the ground, not only to insure a dry wall for the sill to rest upon, but to prevent water from working under it during a rain. Decaying sills are a fruitful source of trouble and expense in wooden buildings.

After placing the sill, lay out upon it with a pencil the position of all doors and windows, and then of each stud.

For spans of not more than 16 feet, 2×10 , or 3×9 inch joists are sufficient. A wider span in the first floor can generally be reduced by a girder in the cellar.

When the floor beams carry a partition, it is customary to put in a girder, or two beams are laid together. Another plan is to place two beams six inches from centres; this arrangement gives not only a bearing for the studs, but an opportunity for solid nailing of the flooring.

No beam should be placed within eight inches of a flue. A space of two inches should also be left between a girder and the chimney breast.

The main partitions upon which the beams rest in a house when the beams do not extend in one length across the building, should be set at the same time as the exterior studding.

Such partitions should rest on a wall of brick or stone, or upon a girder.

Stud partitions should never be used in a cellar. The studs are liable to rot and to harbor vermin.

No beams should be placed on a partition which has not direct support from the foundation, unless the partition itself is trussed.

In all partitions carrying beams, or wherever it is possible, the studs should rest

on 2x4 inch plates, and not on the beams. The object of this is to avoid settlement caused by shrinkage. Timber shrinks crosswise, not lengthwise. The shrinkage of a 2-inch plate would be but one-fourth of the shrinkage of a beam 8 inches deep. In a building of several stories this become a serious difference and would cause the doors to settle and the plaster to crack.

Besides the main partitions there are cross partitions which of necessity rest on the floor beams, as the rooms in the upper stories are usually of different dimensions from those below. It is sometimes possible to truss these partitions so as to bring the strain on the exterior studs and the main partitions.

CHAPTER IX.

THE CONSTRUCTION OF FRAMED TENEMENTS AND FACTORIES.

There is no class of constructive carpentry which requires more care, skill and calculation than the houses or edifices in which a number of persons live, work or congregate, as in this class strength and safety are the most important factors to be considered.

This is especially the case with framed houses which are built to accommodate three or more families, or as they are commonly called "tenements" and factories of three, four or more stories in height, usually running from 35 to 60 feet to cornice, and as these high dimensions necessitate doubling and splicing of vertical supporting posts and other bearing timbers, special attention must be given to the framing so as to insure absolute strength and safety.

To illustrate this I have in this article taken as an example for illustration, the practical framing of four four-story timber

tenements, to be built on a street with a hill or steep grade. The pitch is 4 feet in 25 feet or 16 feet drop in the whole 100 foot plot covered by the four houses. Each house measures 25 feet front by 75 feet deep, and being each on a lot 100 feet deep, it will be seen there is a 25-foot yard left in the rear which is requisite for light and ventilation. Fig. 30

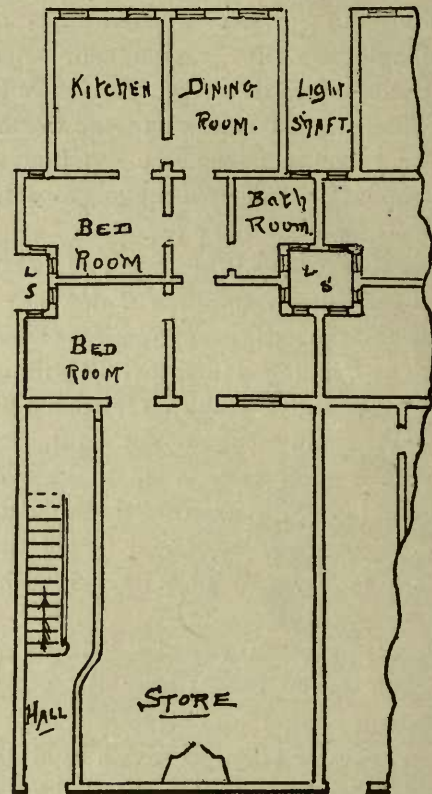

FIG. 30.—PLAN OF STORE FLOOR.

is a plan of one house showing the interior light shafts, which in the case of framed tenements are better laid out square or at right angles as seen in the engraving, in order that the cost be reduced as low as possible, as obtuse and acute angular framing is very costly, not alone in the labor of the framing, but also in the increased cost of the extra material. For this reason it

is always most economical to arrange the framing with square corners, as shown at Fig. 30. In building the stone foundations the first house, to the left, or that on the bottom, has the side, rear and front walls level, so that the sills will be level all around. House No. 2 has its right-hand foundation party wall 4 feet higher, and

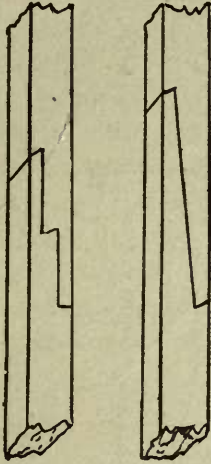

FIG. 31.—SPLICING POSTS.

house No. 3 has its right party wall 4 feet higher still, and house No. 4 has its wall 4 feet still higher, thus compensating for the pitch of the street, which will be seen by a study of Fig 33, which is an elevation of the raised and framed principal timbers of the front of the houses. But the pitch of the street will affect the framing, and unless the right-hand stone foundation wall be built up to the level of each house to the right, it will be necessary to change the sill into a girt or tie, and to mortise and tenon this girt into the front, rear and intermediate posts to properly support the first story floor beams which rest on them, as seen in this figure. Similarly the front and rear sills must be framed on the left-hand end with a mortise and tenon, so as to tie the whole framed construction together. From the above it will be seen

that much study must be devoted to the proper laying out of this style of buildings by the carpenter in order that the timbers may fit when raised.

Now as to the height, which is of course outside the usual limit of one, two and three-story cottages and the like. As the corner and inside party and gable wall posts are so high that it would not be possible to obtain single timbers long enough to make up the whole height, it will be necessary to join two or more sticks end to end, and to brace them in such a manner, that there will be no danger of their springing or buckling. For the best form of vertical joint for this I would refer the reader to sketch shown in Fig. 31 That *splice* on the left is to my mind the most economical and strongest form which can

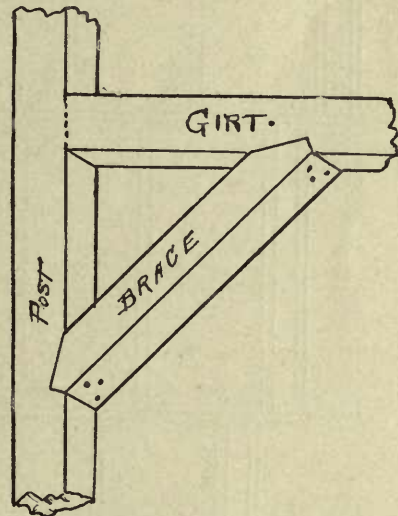

FIG. 32.—FRAMING OF BRACE.

be used in this class of work, for the reason that it consumes only the extra length of the joint on the timber, and is easily ripped down from the end with the saw, and involves no chisel work whatever, if done by a careful hand. This joint is bolted together, and is stronger than that seen on the right, which will require more

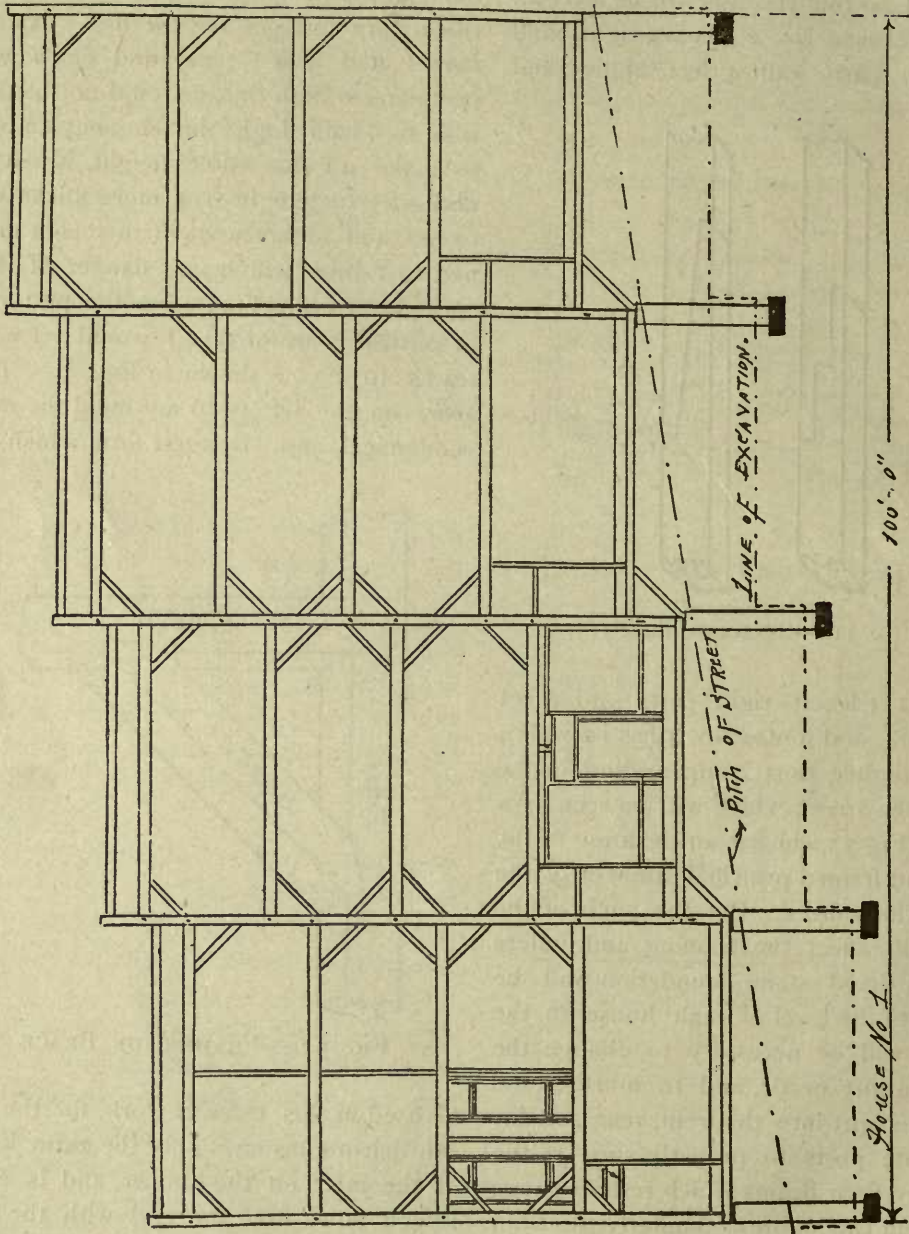

FIG. 33.—ELEVATION OF ANGULAR FRAMING.

cutting, and though it has more bearing surface, is not so good or cheap as the other.

As to the proper bracing of long posts, for this the reader would be wise to follow the simple corner method, which is clearly illustrated in Fig. 32, with the tenon omitted. I am entirely opposed to putting tenons and mortises on these braces, and though the method is old, it is nevertheless bad, because the mortising of the girt weakens it and forms a receptacle for dry rot and insects when the timbers shrink away from each other and open the joint. Therefore a simple scarf with a spiked joint is the best, and the braces are so easy to slip in and nail in place, that the frame is held rigid and immovable, and none of the timbers are weakened in the framing.

This form of building may also be framed and raised on the balloon system, but if this be done I would recommend that at least girts and posts be used to carry the floor beams, instead of a ribbon, which is a weak construction; in fact, the frame should be half frame and half balloon, so as to make the building stiff enough to withstand wind pressure, the weight of snow or any ordinary strain.

Fig. 34 is an elevation of a straight gable, and showing the braces, and this angular framing should be as far as possible introduced when the absence of windows permits it. If possible, also, these high framed houses should be sheathed diagonally. Sill and girts might also be braced from piers and wall for additional strength.

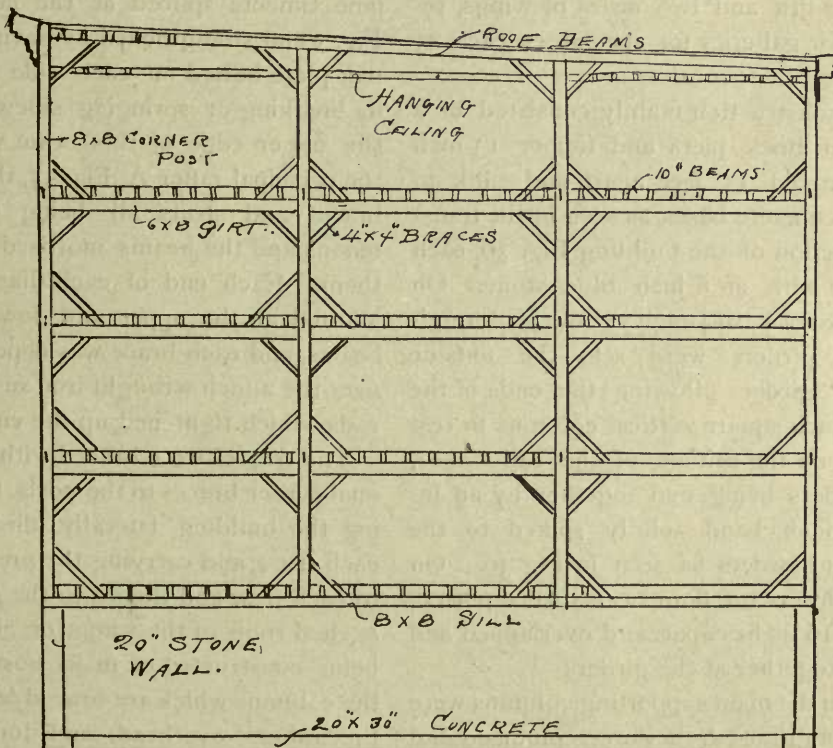

FIG. 34.—FRAMING OF GABLES AND PARTY WALLS.

CHAPTER X.

HOW TO CONSTRUCT A FRAMED AUDITORIUM.

In the last chapter I treated on the detailed construction of framed tenement dwellings; in this I propose to explain fully the method of framing large assembly buildings, as adopted in one of the best known timber auditoriums in the United States, the place where many famous pugilistic encounters have taken place. I refer to the building called the Coney Island Athletic Club.

This immense framed structure was originally designed and built for a skating rink at the time of the skating craze in 1884, and measured 125 feet in width by 300 feet in length over all. The building consists of three parts or sections on plan, namely, a main floor or exhibition part 75 feet in width and two aisles or wings, reserved for galleries for spectators, each 25 feet wide.

The construction mainly consisted of a series of brick piers and timber 13 inch posts, spaced 15 feet apart and sunk to rest on concrete bases, as seen in the transverse section of the building Fig. 36, each capped with an 8-inch blue stone. On these, heavy 12x14-inch yellow pine longitudinal girders were set; the outside lines of girders allowing the ends of the 12x12-inch square vertical columns to rest directly on the centers of the cap stones, the girders being tied together by an inside 3-inch band solidly spiked to the posts and girders as seen in Fig 36. On these girders the floor beams were placed, spaced 16 inches apart and overlapped and spiked together at the girders

When the main supporting columns were framed and raised, they were plumbed and strongly braced to the floor beams with 2-inch plank braces, and thus held until

the braces and wall plates were framed, raised and set. Here I might state that the raising was all done with gin poles, one being a light 10-inch stick of yellow pine timber, used for the post and timbers, and the other, used to raise the trusses, being an immense round stick of Canadian spruce 60 feet long, 10 inches at the top and 16 inches at the butt. Both were *stayed* with rope guys and rigged with four sheaved blocks and tackles, thus giving great lifting power. The last pole was equipped with a drum and horse gear. When the plates were being framed and set, a special gang of men was engaged in framing and putting together the trusses, the design of which is readily seen at Fig. 35. They were of the Howe class, modified to give a pitch to the roof, and consisted of a lower chord or tie beam 75 feet long, made up of two 40-foot 8x12-inch yellow pine timbers spliced at the center as at Fig. 3 and strengthened by having a 2-inch oak plate bolted on each side to prevent its breaking or springing sideways. Into the upper edge of this beam was framed the principal rafter A, Fig. 35, the diagonal braces and struts all being fitted with tenons and the beams mortised to receive them. Each end of each diagonal brace abutted at the upper and lower chordal beams, and each brace was coped out to fit over the 2-inch wrought iron suspension tie rods, which tightened up the entire truss.

The trusses were braced with long diagonal corner braces to the posts, thus stiffening the building laterally, directly under each truss, and carrying the pressure down to each post and thence to the *pent* or *lean to* shed roofs of the wings or aisles, which being constructed of main posts opposite the columns which are braced *laterally* from the rafters overhead, and longitudinally from the plate to the post, thus making it a strong and rigid structure.

On top of the upper chord of the principal trusses short 5-foot uprights, resting on a longitudinal plate were raised so as to give the light from above and permit of

pivoted sashes being set in the sides for ventilation. These were set in frames nailed to studding and were set close together so as to give plenty of air space.

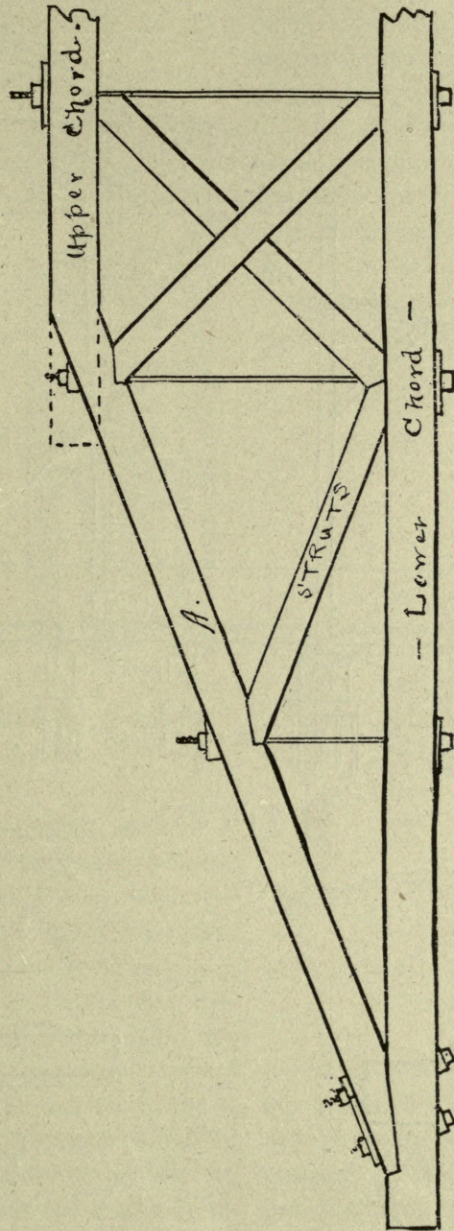

FIG. 35.

HOW TO FRAME A HOUSE.

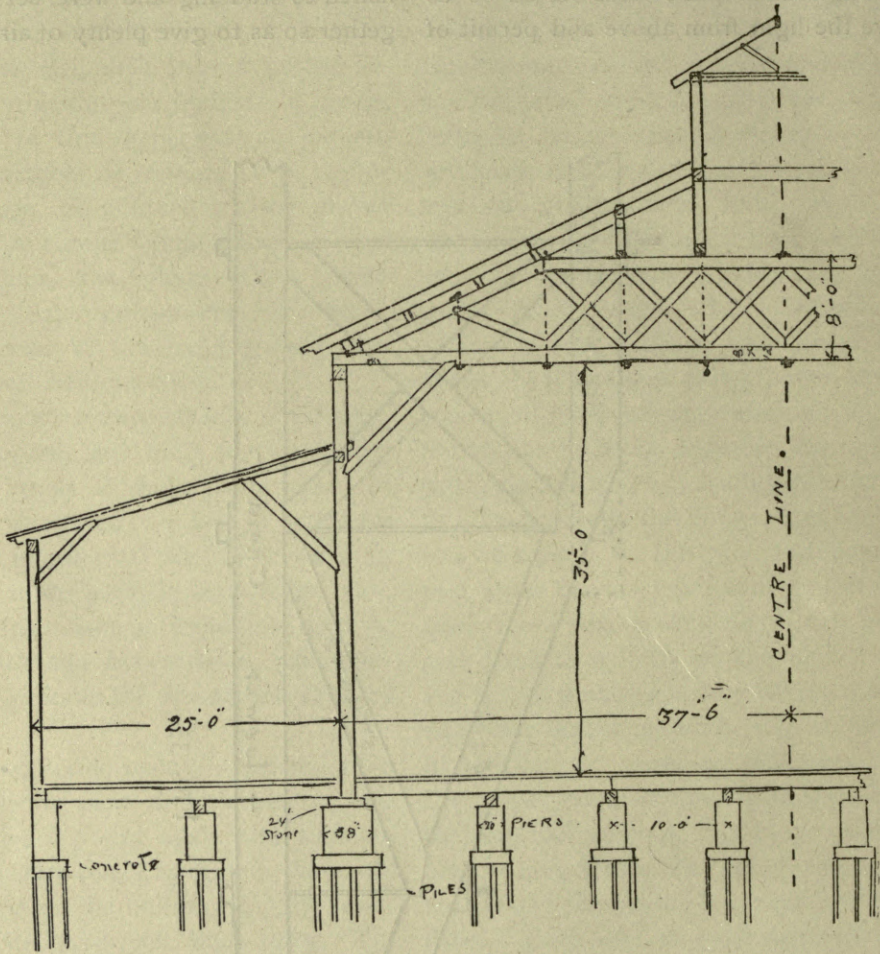

FIG. 36.

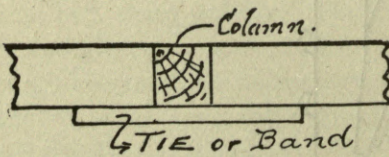

FIG. 37.

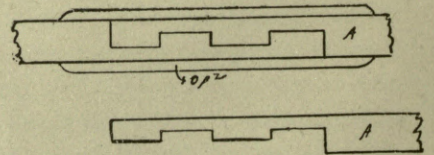

FIG. 38.

CHAPTER XI.

THE CONSTRUCTION OF REVIEWING STANDS
AS USED IN THE DEWEY PARADE IN NEW
YORK.

I know of no greater tribute to the skill, care, ability, and trustworthiness of American carpenters than that evinced in the

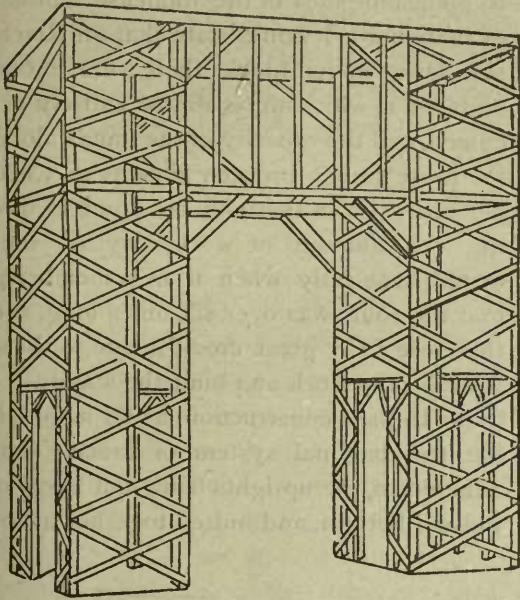

FIG. 39.—GENERAL VIEW OF FRAMING OF DEWEY ARCH.

construction of the triumphal arch and tremendous number of reviewing stands erected along Riverside Drive, Seventy-second Street, Eighth Avenue, Fifty-ninth Street, and Fifth Avenue for reviewing the parade in which Admiral Dewey was the central figure. There were over 1,000 reviewing stands and platforms built to accommodate 2,000,000 persons, and these were framed, raised, braced and nailed in such a way by the union carpenters of New York, that there was not one of them which strained, fell, or caused accident.

In order to show the carpenters of the entire country some of the constructive de-

tails of the carpenter work done during this celebration, we will commence with the timberwork of the Dewey triumphal arch, erected on Fifth Avenue at Madison Square.

This splendid piece of framed and nailed carpentry was built up of various sizes of timbers, running from 8x8 inches to $\frac{7}{8}$ inch scantling, and was carried up on the diagonal system of bracing as illustrated at Fig. 39, which is a perspective view of the timber framing before the staff was put on. (As this illustration is made from memory, I have purposely omitted many timbers so as not to confuse the drawing.) The abutting joints of each length necessary to make the full height of 60 feet were cleated

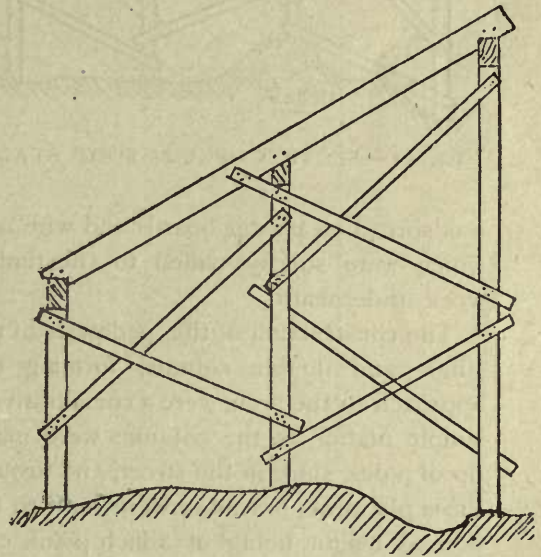

FIG. 40.—SECTION OF FRAMING OF A 20-FOOT STAND.

together, nailed and bolted, afterwards being braced with diagonal braces reversed across on the diagonal on the insides and outsides of the uprights. For the arches intersecting east and west intermediate uprights were inserted, these also being diagonally braced vertically, and horizontal diagonal bracing from corner to corner was

used to stiffen the whole construction laterally. This unusual job of extemporized framing was done without accident, and made so strong and rigid that it sustains the weight of the staff of which the covering and modeled work is composed without a sign of strain or fracture. I might state here that the plaster work and staff

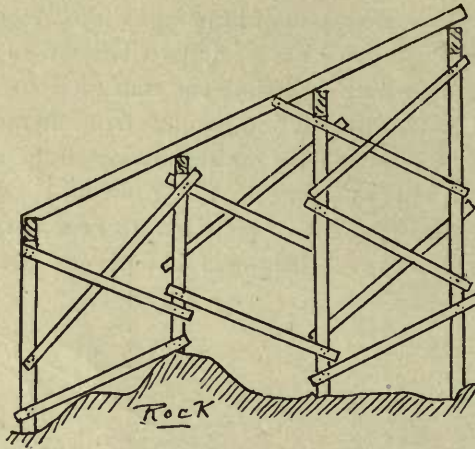

FIG. 41—SECTION OF A 25-FOOT STAND.

was spread on plaster boards and wire lath which were solidly nailed to the timber work underneath.

The construction of the pedestals of the single and double columns, forming the approach to the arch, were a comparatively simple matter, as the columns were made up of poles, sunk in the street, and around these platforms of timber were built to the desired height, being of 2-inch plank carried on 3 feet x 6 inch or other uprights and braced diagonally, all bridging, cleats, etc., being cut in and fitted where required by the sculptors and their assistants, thus forming a rigid groundwork for the artistic work, which so embellished the most important part of the demonstration.

Now as to the construction of the reviewing stands, which were erected for the purpose of giving a better opportunity to see the parade, which consisted not only of

the hero of Manila and many representative citizens, but also 30,000 troops. As this immense body of men occupied five hours in passing a given point, it necessarily followed that seating accommodation should be provided for hundreds of thousands of persons. To do this required millions of feet of lumber and the united labor of 5,000 carpenters and 10,000 laborers. In order to give some idea of the immense amount of seats built, I would state that on Riverside Drive on ten blocks there were 30,000 seats built, which were almost entirely occupied, and the capacity of the stands along the route varied from ten persons to 5,000 persons. From these figures some idea of the vast amount of work may be estimated, especially when it is remembered that the route was over six miles long, and therefore I say great credit is due to those who did the work and built the stands.

As to their construction, as far as possible the diagonal system of bracing was adhered to, the uprights being cut harefoot top and bottom, and butted together at the

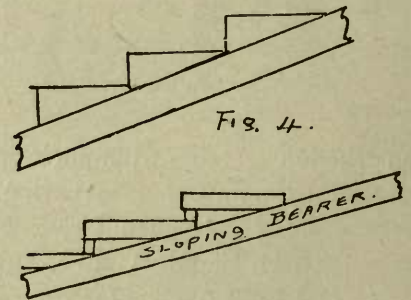

FIGS. 42 AND 43.

joints and secured with cleats, well spiked, to prevent their buckling or spreading.

At Figs. 40 and 41 sections of the methods are represented, and here will be noticed the great value of this form of bracing, as by its aid comparatively light uprights may be made capable of sustaining a very heavy weight, provided the possibility of shearing

or buckling be reduced to a minimum. Shearing can only be prevented by having a sufficient area of timber and of a nature sufficiently tough to fully resist the compressive force. Buckling is prevented by cross ties, braces, etc, or the tensile strength of the timber itself, and the height of the post, and superincumbent weight regulates this.

16 inch uprights, well braced, and nailed with *wire nails*, which nails were almost universally used in the stands, the reason of which, I since learned from the builders, was to save the timber as much as possible, as these nails pull out easily with the hammer.

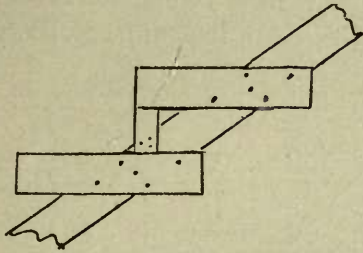

FIG. 44.—BRACKETS NAILED ON.

The majority of the reviewing stands from 6 to 25 feet in height were built of 4x6 inch and 6x6 inch spruce timbers, spaced about 6 feet on centres and braced about 6 feet in the height. The sloping bearers varied from 3x6-inch to 3x10-inch, also of spruce, and braces from 2x6, 2x4, 2x2, 1x6, 1x7, 1x2 and so on as the timber came, some of it being second-hand timber. Apropos of second-hand timber, I would say that its extreme hardness and brittleness lessens its value as a bearing timber, in addition to its great liability to split when being nailed, which latter peculiarity I noticed existant in much of the hemlock used.

The brackets were mostly nailed on the top edges of the sloping bearers, as at Figs. 42 and 43, though some, those of 1 1/4 inch hemlock, were spiked on the sides in the way seen at Fig. 44 and fitted with a small upright. Many of the stands had chairs on the platforms which averaged 4 feet in width, and again many had simple benches consisting of 9 inch 7/8 boards on

CHAPTER XII.

HOW TO BUILD A GRAIN ELEVATOR.

Grain elevators are, as far as I know, of a composite construction, namely, of

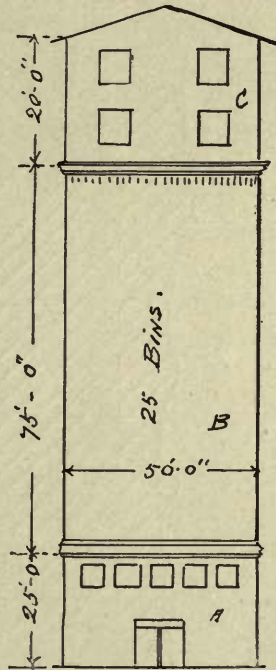

FIG. 45.—ELEVATION OF AN ELEVATOR.

masonry, iron, and wood. The usual method of construction followed is, as in Fig. 45, to make the footings and foundations concrete or stone, the first and second stories of brick, as A, as these are the distributing floors, and the superstructure of timber. For the better elucidation of this I would refer the reader to the sketches

which accompany this description, as they are from the actual work as I have seen it built.

As the inquirer will perceive, the second section or story is built of timber, so as to form bins, or boxes, for the purpose of receiving and storing the different kinds of grain; and in order to construct the bins a very unique yet simple form of construction is followed out. Fig. 46 is a cross-section taken through B, the second story, or bins, and fully illustrates the method.

It consists of starting the bottom of 2-inch or 3-inch layers of plank timber, 14 or 16 inches wide, on top of the first story masonry and gradually stepping back in 1-inch steps till the thickness of the wall, 6 or 8 inches, is reached, crossing all joints intersecting where possible and scattering all joints so as to obtain the greatest possible strength. All nails are long enough to dovetail into three thicknesses of timber, and steel wire. Corners are overlapped. All this will be clearly under-

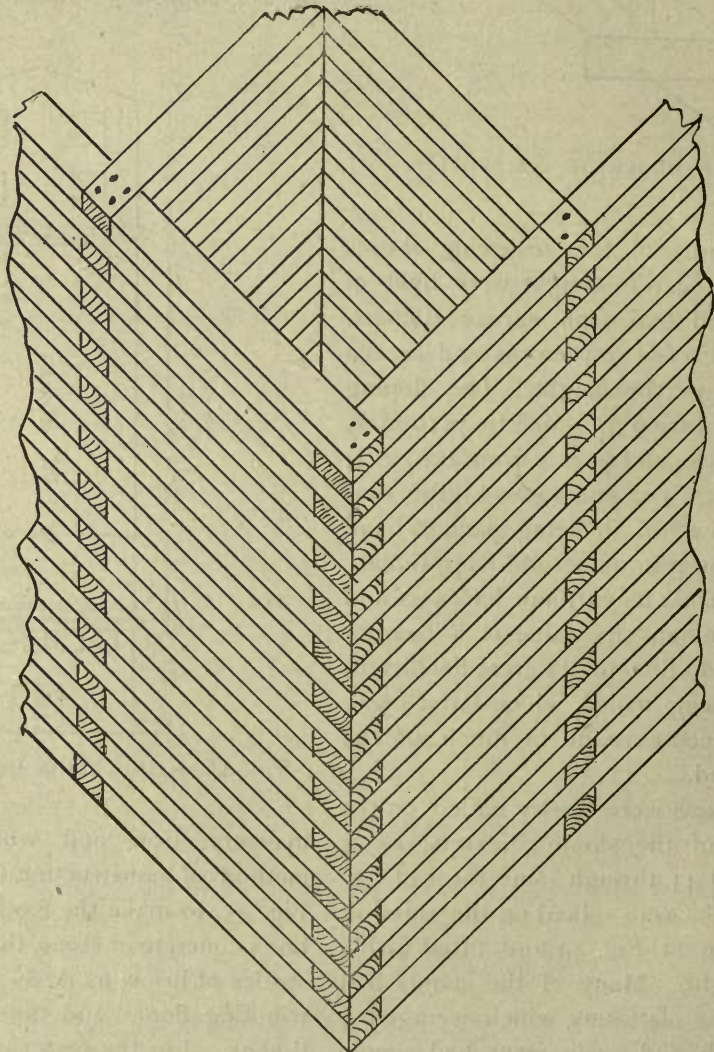

FIG. 46—METHOD OF BUILDING BINS BY OVERLAPPING AND CROSSING JOINTS.

stood by a close study of Fig. 46, which is an isometrically projected drawing of one corner of the bin section, showing the laminated, or built-up, method of constructing the bins. On account of the ever-varying grains, breaking of joints, and multitudinous quantity of nails (dovetailed), this form of building bins is of enormous strength, and can be carried to a great height, and makes a very strong, capable



FIG. 47—PLAN OR SECTION.

house. The amount of cutting and fitting and nailing involved is tremendous, but the bins are of great strength and content, each of those represented here containing almost 7,000 cubic feet. When the bin section is built up to a height of 75 feet, the upper portion C is framed and raised of wood on a braced-frame principle, so as to be light and strong. The whole should be covered with slate, iron, or tin.

CHAPTER XIII.

FRAMING PROJECTING STORIES AND BAY WINDOWS; ALSO GENERAL HINTS.

This problem in house framing is one which is coming up continuously in the construction of small frame cottages and will be found useful by carpenters who do this class of work. The Queen Anne

style of shingled house especially, as in their design, is the most effective.

Referring to Fig. 48 of the sketches, readers will comprehend what is meant by a projecting story, and will see that it is the pushing out of the front of the second story beyond the front of the first story below; also by setting out the third story or gable beyond the second story, thus getting a very effective front. This construction should be done carefully and with a close attention to the strains which will be permanently placed upon the timbers, so that there may be no straining of the timbers and consequent cracking of the plaster, so that I will now proceed to give the best form of construction to be followed. Fig. 49 is a section of the three stories of the house from the sill to the ridge showing the constructive timbers, and it will be seen that as the greatest strain comes on the first story, the timbers of that story must be of increased strength in order to safely support the superstructure above. This will include the posts, studding, floor, beams and plates. For an ordinary two-story framed cottage the posts will do at 4 inches x 6 inches, the studding at 4 inches x 4 inches for the first story, and 3 inches x 4 inches for the second story; the second story floor beams will do at 3 inches x 10 inches and the roof at 2 inches x 8 inches. All these timbers will require to be carefully and accurately framed and *braced* to make sure that all support the framing above, and prevent that lateral movement which is only too common in modern balloon frames, so that the lower stories must be braced at angles to stiffen it thoroughly if possible. It is best to frame the angles with a mortise and tenon brace; but should the expense prevent this the balloon framing and braces which I illustrate in Fig. 48 will be sufficient; when the studs are thick

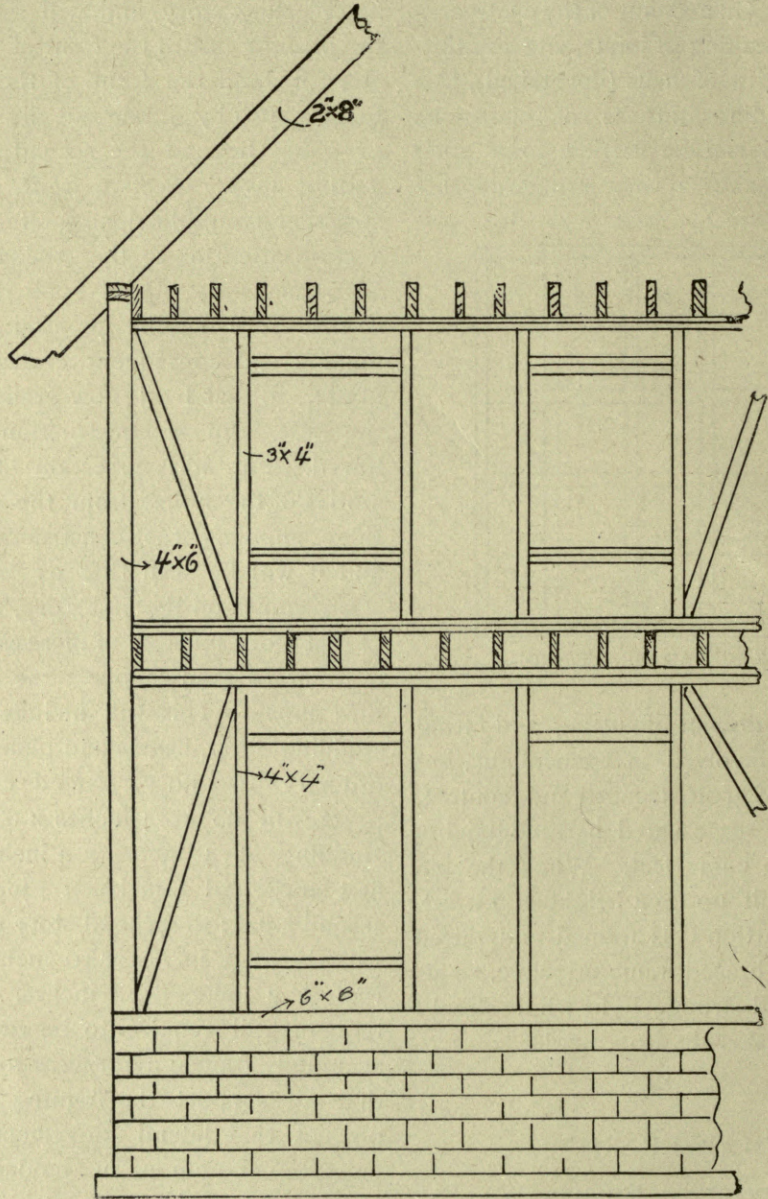

FIG. 48—FRONT VIEW OF FRAMING.

as 4 inches x 4 inches or 4 inches x 6 inches it will not be necessary to double them at doors and windows nor need the headers be doubled.

When framing over openings it is essential that the plates supporting the first and second story floor beams will be required "to be trussed," and the strain carried directly over to the upright studs without resting on the cripples or headers. This trussing must be inserted over large door openings, and should a bay window occur, a lattice girder truss from 12 inches to 18 inches deep will require to be placed under the floor beams to prevent any subsidence of the plates.

Regarding the use of a ribbon, which some favor in projecting out second stories, I would say that it can be used with perfect safety if of not less than 10 inches in depth, but it is not an economical method of construction, for the reason of too much cutting of the timber and consequent waste. The methods illustrated in Figs. 48 and 49 carrying a separate plate carrying each tier of floor beams is the simplest and easiest raised. It will be noticed in these figures that the corner posts and studding of the sidewalls are carried up so as to leave the top of the plate of the sidewalls level with the top edge of the ceiling beams. Including these suggestions pertaining to projecting stories, I might say that this information was requested from me some time since, and that it is only now that I am able to present it to my readers.

DIFFERENT METHODS OF BRACING PARTITIONS.—After careful observations of many partitions, I am satisfied that the average carpenter and builder is not really aware of their true structural value. Most mechanics regard a partition simply as a wood and plaster wall, for separating rooms and supporting the floor beams above, and

though these are their principal objects, they should always be used and built as a part of the structure of the house to increase its statical strength. To this end I

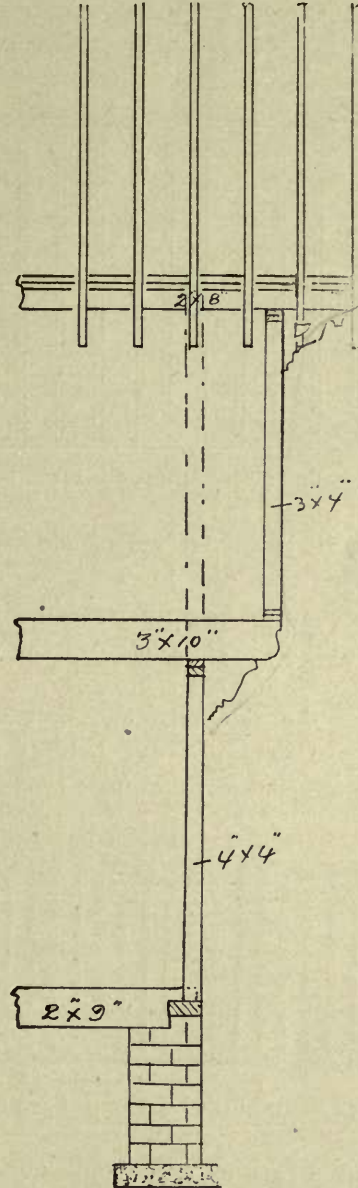

FIG. 49—SECTION OF STORIES.

have deemed it advisable to set before my readers a few suggestions regarding these important details of building construction.

As I have stated in previous articles, the

usual method of erecting partitions is to set the studs 12 or 19 inches apart from center to center, setting all studs plumb, then to cut in horizontal bridging as illustrated in sketch, Fig. 50; this bridging is sometimes slightly pitched as shown by the dotted lines, so that it may tighten in case

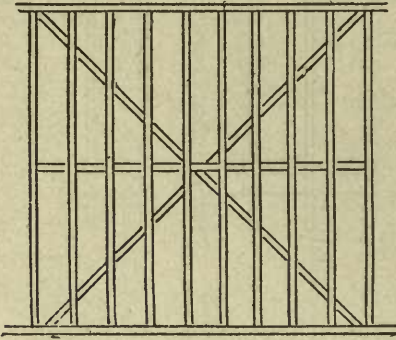

FIG. 50.—PARTITION BRACED DIAGONALLY.

there should be any settlement, and it is very little better than the horizontal bridging. In frame houses I would recommend that cross partitions in the center of the house be "braced" and not "bridged" in order to stiffen the side wall and prevent the building straining, or any liability of its being strained by any outside forces such

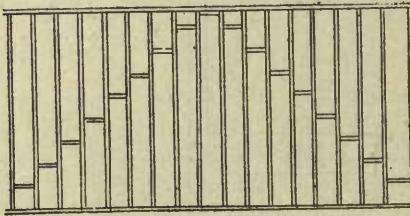

FIG. 51.—BRACING A LONG PARTITION.

as wind pressure, etc. This "bracing" can be very economically done by the method illustrated in Fig. 50; as will be seen, it consists of simply cutting in a line of bridging from corner to corner diagonally, each piece being driven down until it tightens.

Fig. 51 represents a method which the writer has successfully followed in bracing a very long partition, and it will be noticed here that the bridging is cut in between the studs, each piece being nailed in horizontally. The method is, however, somewhat faulty, as the studs are liable to be bucked or sprung when nailing in the bridging, for this reason I would suggest that the curved or arched bridging shown in the engraving Fig. 52 be adopted for long partitions, especially if it supports floor beams in the center of a span or be a "fore and aft" partition. This form of introducing the arch formed of small pieces of studding is, as far as I know, not usual and has been followed by the writer in many jobs, with the result that each parti-

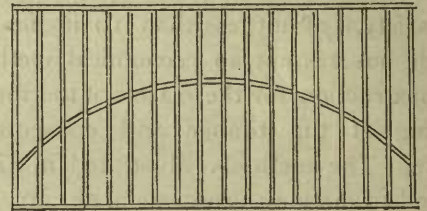

FIG. 52.—ARCHED OR CURVED BRIDGING.

tion was not alone self-sustaining on each story, but was also rigid.

When partitions are built of studs set on their flat, they should have more bridging than those set the 4 inch way.

Partitions should, if possible, be filled in with some incombustible material to render them both sound and fireproof.

FRAMING WOODEN WALLS FOR WINDOW OPENINGS.—Herewith I illustrate by two sketches the methods to be followed in framing wooden walls for window openings. Fig. 53 is the plan and on it will be seen the different details of construction of the window frame, including the weight pocket, which should ordinarily be $2\frac{1}{2}$ inches from the back of the pulley stile to

the face of the stud to permit the weights to pass freely up and down. The top header is usually doubled and the construction is the same as shown on Fig. 54. Fig.

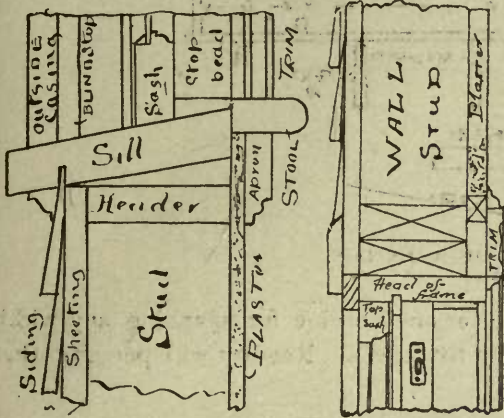

FIG. 53—
SECTION OF SILL, ETC.

FIG. 54—
TOP HEADERS.

53 is the bottom header with the sill stool and apron, and the construction is clearly shown and easily understood by a close

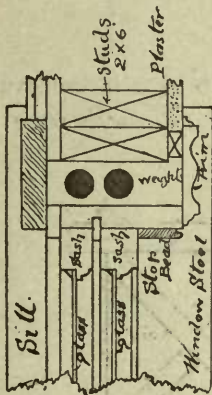

FIG. 55—WINDOW FRAME.

study of the pieces, and Fig. 54 is the top header referred to above. About 1 inch is allowed to permit the frame to slide into its place.

CHAPTER XIV.

HOW TO FRAME CHEAP TIMBER BRIDGES FOR ROADWAYS, ETC.

The construction of good, cheap bridges for spanning small rivers, valleys, ravines and such, on country roads, necessitates some care and originality; and I have found that this class of work, though not very frequent, still occurs in many localities, also cheap timber roofs. For the purpose therefore of explaining the best and cheapest form I will present in this article several methods of simple trussing which carpenters will find useful. For very short bridge spans of from 4 to 6 feet, the best form is a simple series of 3 or 4 heavy yellow pine or spruce timbers spaced so as to come directly under the wheels, and large enough to sustain a weight of from two to five tons in the centre of their bearing. The width of the roadway for two lines of vehicles, allowing room to pass easily, should be from 16 to 18 feet, with 4 feet for sidewalks, so that it will be necessary to lay out a cross section of the prospective bridge, place the stringers or longitudinal bearing timbers in such positions as they will best resist the movable load. According to the best engineering authorities the moving load provided for should be, for spans under 100 feet, 70 to 100 pounds per square foot; for spans from 100 to 200 feet, 50 to 80 pounds per square foot; for spans over 200 feet, 40 to 65 pounds per square foot.

At Fig. 56 readers will see a cross section of a highway bridge spanning a creek about ten feet wide. There are four principal stringers under the roadway which are trussed with the centre post and 1-inch wrought iron suspension rod in the manner shown in the under side of the engraving. This suspension rod passes through the ends of the stringer and is tightened

with plates, washers and nuts. As will be seen there is four feet allowed on each side of the bridge. At Figs. 57 and 58, I show longitudinal and transverse sections

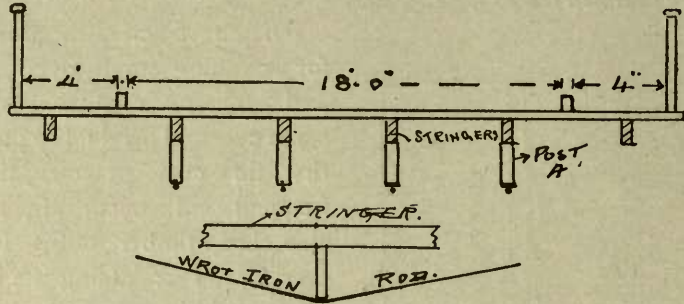

FIG. 56—SECTION OF A BRIDGE.

side for sidewalks. The stringers measure 8x12 inches, the roadway 3x8 inches of a small bridge for spanning any width up to 25 feet. Readers will perceive that

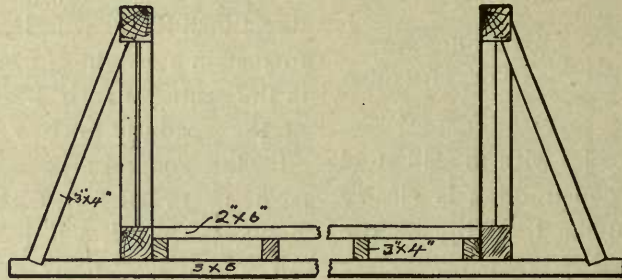

FIG. 57.

and the guide pieces 5x8 inches; the guard rails for the bridge can be made up of this form of bridge is constructed on the Howe truss, and very strong bridges can

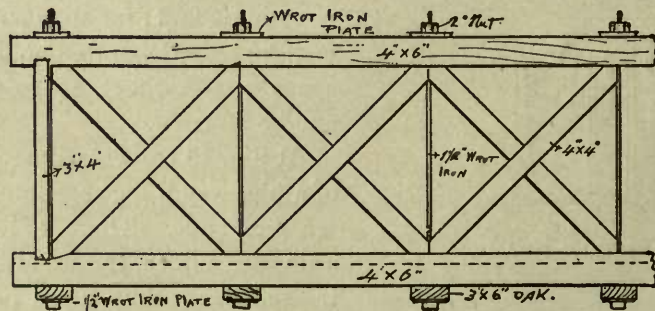

FIG. 58.

diagonal or some other simple pattern, but they should be well braced from the under be built by increasing the depth or distance between the upper and lower chords. It

will be understood that the sizes of the timbers must be increased in proportion up by this method, thus leaving the entire covered space underneath free from col-

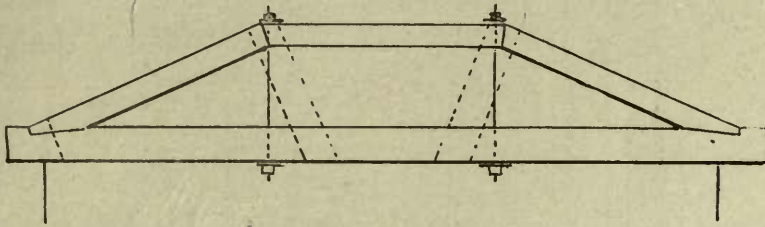

FIG. 59—SIMPLE TRUSSED BRIDGES.

with the increase of each foot of span in order to resist the strain placed thereon. umns or supporting posts. For roofs of short span, shingled or slated, the trusses

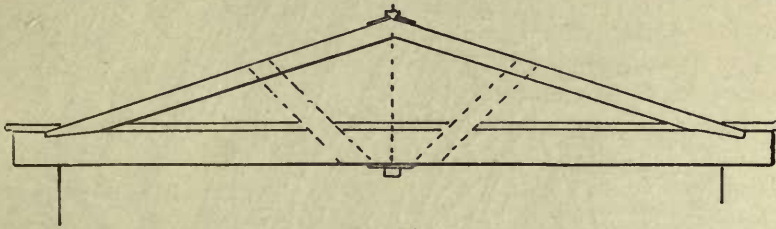

FIG. 60.

Fig. 59 shows another form of simple trussing for a span not to exceed 25 feet. seen in the engravings can be readily adopted.

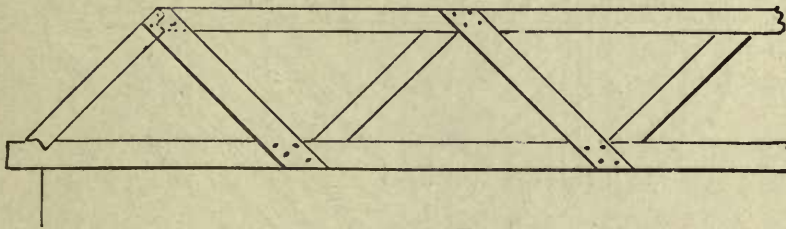

FIG. 61—LATTICE TRUSSINGS.

Fig. 60 is a simple form for a span not to exceed 15 feet.

Fig. 61 represents a very simple form of diagonal lattice trussing, by means of which a very cheap and serviceable bridge may be built for spans of 20 feet, but the writer would not recommend bridges to be built of this kind, as the limits of nailing and the sizes of the timber prevent the adoption of this method. For flat roofs the diagonal lattice can be used or on barns or long buildings bridge girders can be built

CHAPTER XV.

HOW TO FRAME A LOG CABIN.

Having been particularly impressed with the picturesque beauty and constructive stability of the log cabin or "slab house," I have in this chapter evolved some details concerning them which will be found of value to all mechanics.

At Fig. 62, I place before the reader an isometrical drawing of a "slab" or half log-house, showing two sides and the roof.

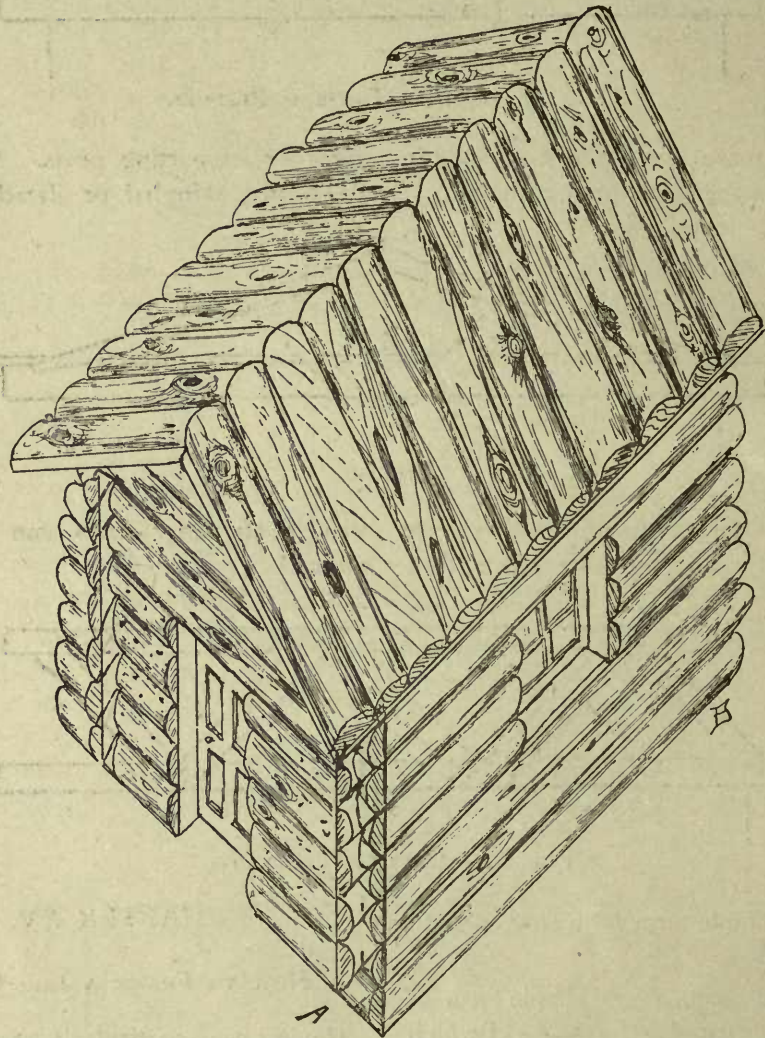

FIG. 62—A SLAB LOG CABIN WITH SLABS HALVED TOGETHER.

The slabs consist of one-half logs or outside slabs of trees with the bark left on. Each slab has a straight face and parallel straightened edges, and at the corners they are halved together, as seen at Fig. 63. The round side is mitred so as to form a close joint, and continue, as far as possible, the round outline of the timber. Short blocks may be fitted to the outside ends to make it appear as if the whole round tree was in the house. This construction makes a very excellent house without resorting to the expedient of patching, and makes an artistic dwelling by hollowing out the ends, which will require to be extremely well done or the joints will show and spoil the appearance of the house.

A log house framed by this method, which only entails the splitting of the tree in two halves with the saw, makes a very healthy house, as it gives a comparatively smooth surface inside and makes close joints, thus making the interior very comfortable, and it can be made more so by furring the half logs vertically and ceiling inside with $\frac{5}{8}$ or $\frac{7}{8}$ inch match boards

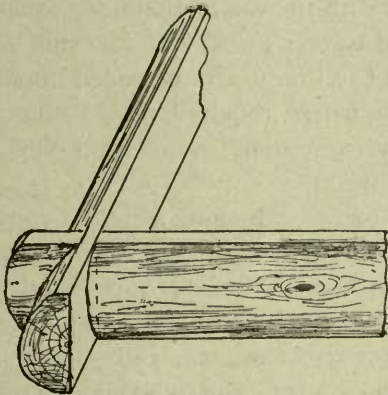

FIG. 63 —SLABS HALVED TOGETHER.

laying them horizontally from the floor up. If, however, the builder should be out in the woods, far away from the valuable aid of the steam saw mill, he can frame his

log house to the halved and mitred joint I illustrate in Fig. 64. Here are shown two

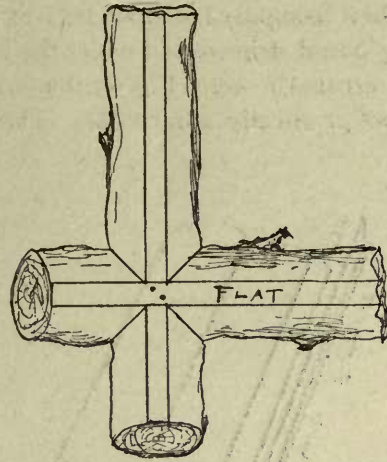

FIG. 64 —METHOD OF FRAMING WHOLE LOGS TOGETHER BY HALVING.

trees of about equal average diameter, sized down to parallel straight edges and halved and mitred to a close joint. These mitres and halves may be sawn or chiselled out and will make a very strong solid wall without much labor, if straight young trees can be procured for the job. The principal labor consists in getting the straight joints. These walls can be put together without nails.

At the rear of Fig. 62, will be seen the simplest way of building a house of this description, which consists of simply cutting, fitting and abutting the ends of the slabs forming one end, against the straight inside faces of the side. This construction will be very well where the end is not seen as in the engraving, but where it is the appearance is not good, though much time is saved. A handy and intelligent mechanic, of resource, and a good fitter, can make a very handsome house, by using any of the foregoing forms of construction. If it be possible each tier of slab or logs might be the same width all round the building, so as to avoid patching. If any piecing is to

be done, it should be at the top, or some place where it will not be visible.

Regarding the roof, I would state that it is best composed of half logs or slabs with grooved strips nailed under the joints, as represented in sketch Fig. 65, thus making the roof practically water tight. The roof

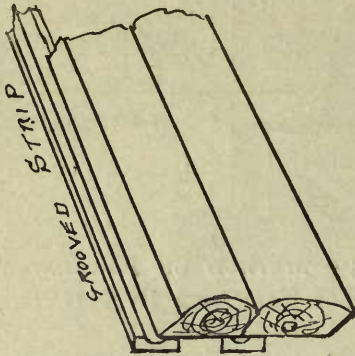
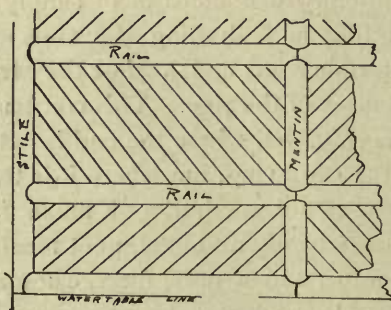

FIG. 65—ROOF SLABS WITH GROOVED STRIPS UNDER JOINTS.

should have long, overhanging eaves or cornices, and a *comb* well overhung at the ridge line. The roof will, of course, require more careful workmanship and fitting than the side walls. In conclusion, it may be said that almost any skilled carpenter may thus build himself an excellent shop,



SLAB PANELING.

shed or dwelling in any locality where the timber is available, at the expense of only

the labor involved in handling and raising the different pieces.

One of the important things I would urge on all mechanics is to study out their work and arrange a mental plan of procedure before laying out work or commencing to use the tools. Deliberation and method will always mean a successful mechanical conclusion.

To illustrate this, I would state that in framing small houses, costing from \$1,000 and up, I find that most foremen in their balloon framing take the measurements off the plans and push up the beams and striding without making any provision for the windows and doors; especially is this the case where bay windows occur. The result is there is a lot of cutting out, and nailing in, of studding when the frame is raised and ready for the sheathing. Personally, I believe in the foreman going ahead and laying out the entire stuff for the beams, sills, walls, partitions, plates, etc., before the men arrive on the ground and commence work. If he be a careful and capable mechanic, with an accurate head-piece—a knowledge of plans and familiar with the use of the steel square, he should be able to cut out his stuff on the ground so that it can be nailed in position exactly where required, thus saving time, money, and much vexation going over work twice.

All pieces of framing should be marked with their name and position when framed, so that they be readily picked out when required, as sill, west-side, wall-plate, north bay, collar-beams, etc, giving each piece its proper name and position. By doing this, the carpenters on a job will be able, in the absence of the foreman, to pick out the stuff and nail it in position.

Some of the best mechanics, I find, take the plans home and make a framing outline plan of each floor, wall, partition, roof

etc., and mark on each line the exact length to lay out and frame each piece, thus making sure their measurements will be correct. This can be done to $1\frac{1}{2}$ or 3-4 scale with an ordinary two-foot carpenter's rule, and is a positive way of obtaining accurate measurements when laying out.

Above all, let me warn carpenters who lead or are in charge, to avoid too much rushing, as it must of necessity mean mistakes or the loss of a job.

One of the most prevalent omissions which is to be found in new work is that

of omitting to set the water table before commencing to clapboard and simply putting on the bottom course and continuing up. This is a very deleterious practice and should never be permitted by good mechanics. In every case the water table should be set and levelled all round the house the very first thing, and, if possible, well painted, then the corner boards nailed together and set up and finally the clapboards put on, with the bottom course well beveled and fitted close to the pitch of the water table, so as to form a water-tight joint.

HOW TO FRAME THE TIMBERS FOR A BRICK HOUSE.

CHAPTER I.

IN WRITING this part I have endeavored to follow, as closely as possible, the methods of construction laid down by the building laws of the City of New York, as

By referring to Fig. 1 of the illustrations, readers will be enabled to obtain a very clear example of the floors of a city house or flat in course of construction. There are four stories, supposed to be partially

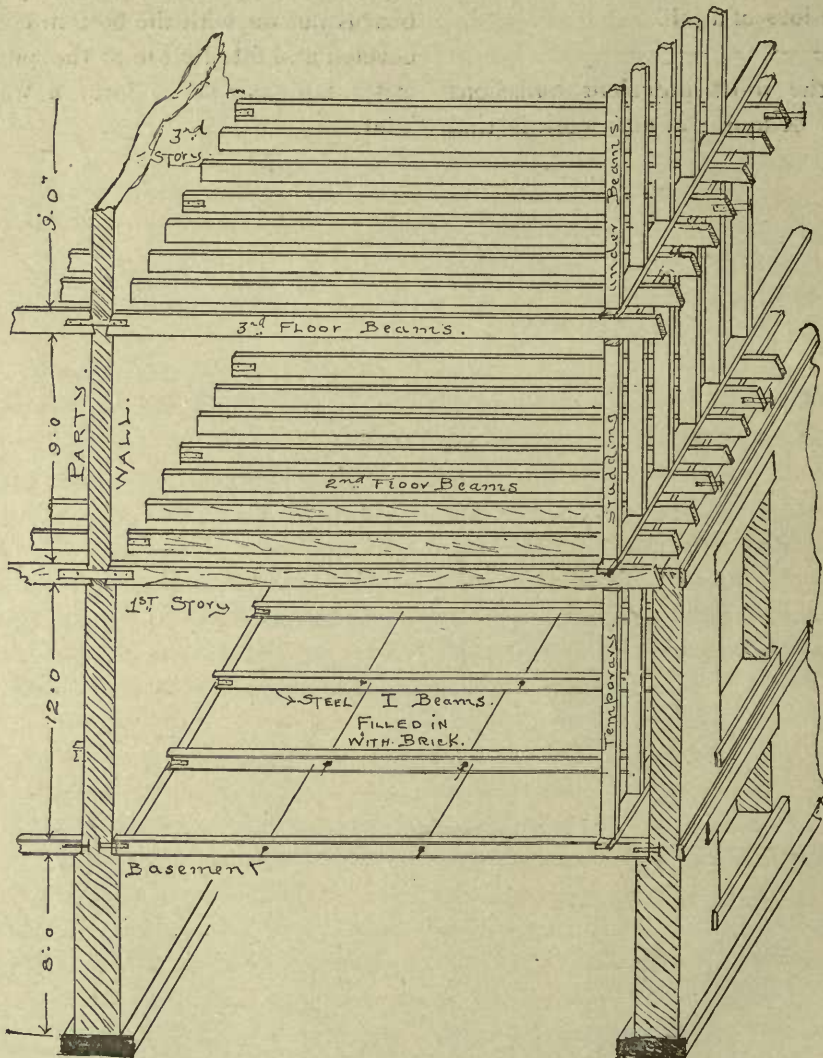

FIG. 1.—PROJECTED VIEW OF FRAMING OF A BRICK HOUSE.

they embody the best forms of construction existing, and are both semi-fireproof and economical.

erected, namely—basement, first story, second story and third story. The brick party wall, on the left, is carried up to above the

third floor beams, and south front is built to the level of the second floor beams. The first floor is fireproof; that is to say, it is constructed of steel beams, filled in with brick arches. The thrust of the arch between the beams being resisted by the wrought iron tie rods, seen in the engraving, which is an isometric section of a corner house, placed on the northeast corner, showing the south gable front. Fig. 2 is the projection of the framing of the

terra cotta arches between I beams will be seen. It consists of 2 inch x 4 inch or 2 inch x 6 inch spruce joists laid lengthways on top and bottom flanges of each I beam; the bottom joist being hung to that on top by means of 1 inch x 3 inch or 1 1/2 inch x 4 inch spruce cleats or strips. The curved bearers are set on the bottom strips and nailed thereon and the battens are laid on loose edge to edge, thus making the centres easily removed from the arch, to

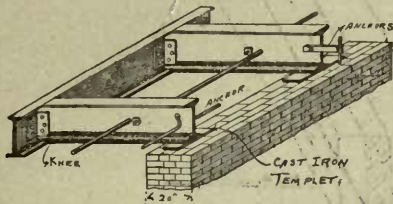

Fig. 2—Method of I Beam Construction, with Tie Rods, Knees, and Two Different Styles of Anchors.

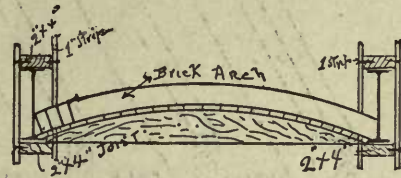

FIG. 5—METHOD OF SETTING CENTRES FOR FIREPROOF FLOORS.

first story fire-proof floor, showing how the I beams are bolted together by knees. It

the next opening, when the cement has set sufficiently hard to allow it, by simply wedging off the strips from the upper joist. The writer has seen many arches turned on this simple and cheap form of centre and it works admirably, carrying both men and material safely. The cleats should be nailed opposite each other on different sides of each beam, and be spaced about six feet apart. Wire nails are the most reliable for this job.

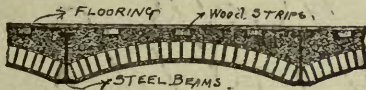

Fig. 3—A Fire-Proof Floor, with brick Arches, Leveled up with Concrete and Wood Strips, Imbedded for Flooring.

also shows the tie rods, anchors and temp-lets under the beams on the brick founda-

At Fig. 1 it will be noticed that there is a temporary line of stud partition placed back of the front wall at each story. These are inserted for the purpose of supporting the several tiers of beams on each floor, till the front is built up to them; as the practice usually is to build the side, rear and party walls first, and then build the fronts up to them. The reason of this is that the front stone-setters or front bricklayers, work much slower than the rough wall men, and, in consequence, the temporary partitions are placed by the framer, or carpen-

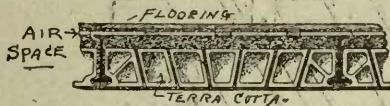

Fig. 4—Hollow Terra Cotta Arch Fire-Proof Floor, with Concrete and Wood Strips Imbedded to Receive Flooring Nails.

tion wall. Figs. 3 and 4 show two details of construction for filling in between the beams.

At Fig. 5, a very inexpensive system of setting centres for turning the brick or

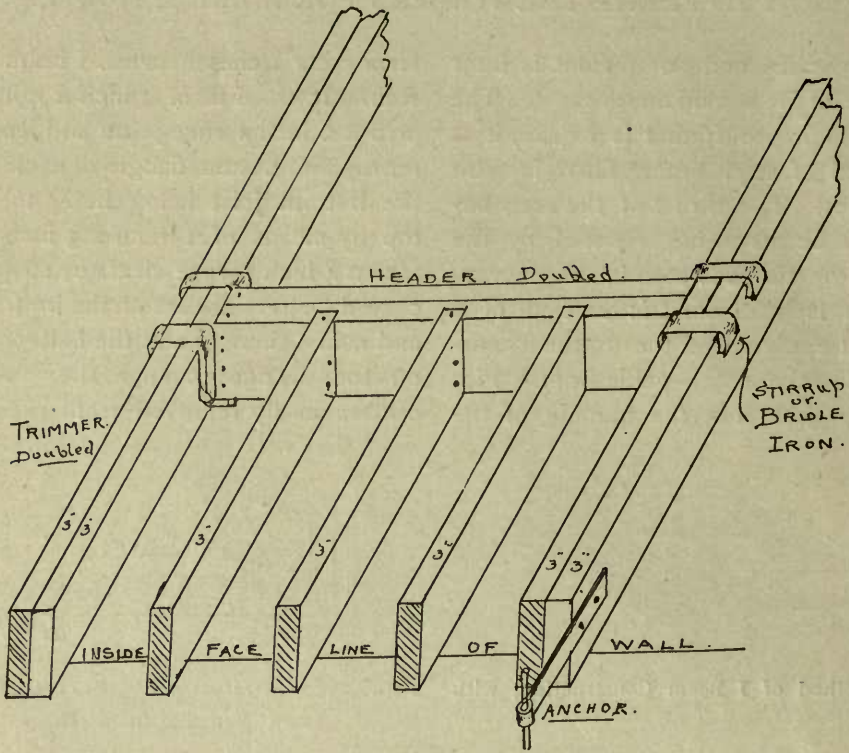

FIG. 6—HEADERS AND TRIMMERS DOUBLED, ALSO FRAMING OF FLOOR BEAMS.

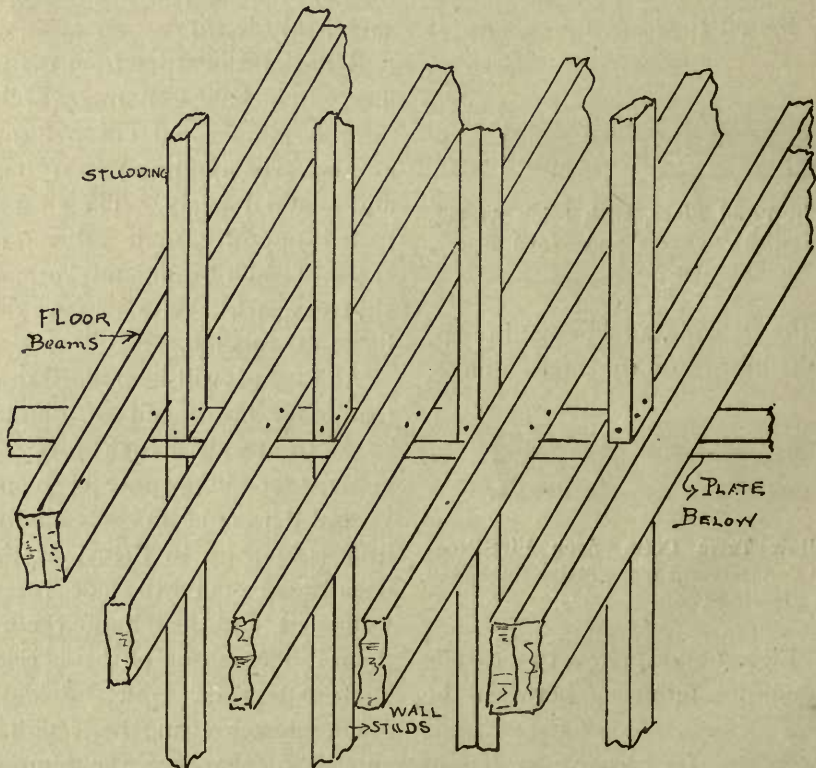

FIG. 7—PROJECTED SECTION OF FORE AND AFT STUD PARTITION AT FLOORS.

ter, so that no time may be lost, or men delayed. There is no waste timber in using this expedient, as the studding and plates, shown on the illustration, are used in the inside partitions when the roof is on and they are being set; but great care must be used in setting the beams level. For this end the measurements must be carefully made and the studding cut the exact length. The New York building law, however, calls for *not more* than two stories of any wall to be built in advance of any other wall, so *that not more than two rows of temporary partition should be needed*. These rows of studding should be kept back at least 3 feet from the face of the wall.

When the beams are being framed their ends must be beveled. They are usually 3 inches thick, and *must* be beveled to not less than 3 inches, or the square of their thickness. This is also shown in Fig. 1, together with the method of anchoring the beams to the brick walls. It will be noticed here that in the party wall *strap* anchors are used, and in the gable T anchors. If there be two gables, side walls, or the beams on opposite sides of the party wall be on different levels, then T anchors must be inserted, and all anchors should have the T at least 8 inches, or the thickness of two courses of brick in the wall. All wooden *trimmers* and *headers* should not be less than one inch thicker than the floor or roof beams of the same tier, when the header is 4 feet or less in length; and when the header is more than 4 feet and not over 15 feet in length *or span* the trimmer and header beams shall be at least double the thickness of the floor or roof beams, or be made up of two beams spiked together. All this I here illustrate at Fig. 6, which is so clear as to fully explain the construction without further explanation. I would state here that it is scarcely necessary to bevel the roof beams, as the de-

crease of 4 inches, from a 12-inch to an 8-inch wall, leaves it unnecessary. All wooden beams must be trimmed away from all flues, not less than 8 inches from the flue. Fireplaces must have trimmed arches to support the hearths, 24 inches wide, measured from the face of the chimney breast. The several tiers of beams must, of course, be anchored, as before described, and the anchors should not be less than 6 feet apart, or nailed on every fourth or fifth beam, as represented in Fig. 1. Anchors should be of wrought iron, $\frac{3}{8}$ of an inch thick and $1\frac{1}{2}$ inches wide, nailed with $\frac{1}{4}$ inch nails. Beams resting on girders may either be overlapped, the width of the girder, or abutted, end to end, and tied together with a double strap.

Concerning the method of anchoring the front wall. I show it in the engravings

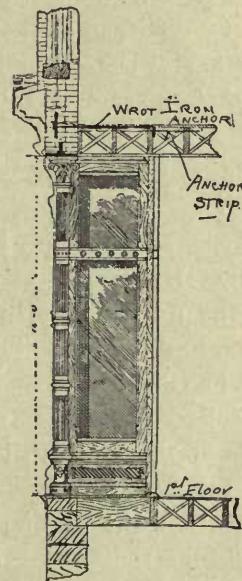

FIG. 8—SECTION OF FRONT OF STORE, SHOWING ANCHORS, STRIPS, BEAMS, ETC.

Figs. 8 and 9. The plan of the roof, Fig. 9, shows that every tier of beams front and rear must have, opposite each pier, hard

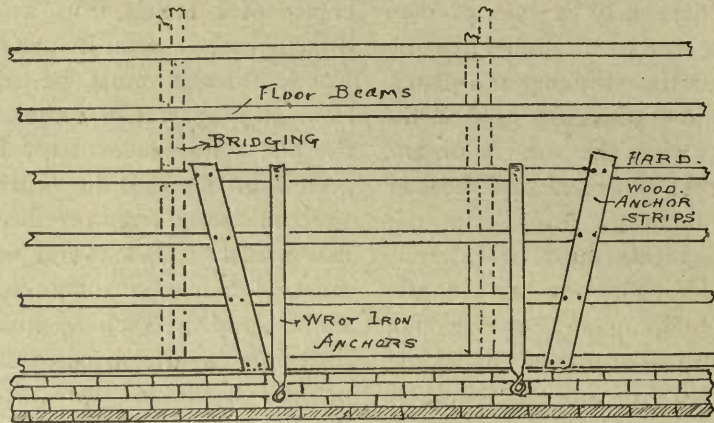

FIG. 9—PLAN OF FLOORS SHOWING METHOD OF ANCHORING FRONT AND REAR WALLS TO BEAMS

wood or hard pine anchor strips (seen in Fig. 9) dovetailed into the beams diagonally, which must be inserted in at least four beams and nailed to each, but they *must not* be let in, within four feet of the centre line of the span of the beams between the walls. The wrought-iron anchors are then placed as I have drawn them in the illustration. The section of the front. Fig. 8, will show better how the anchors hold.

In regard to stud partitions, I would say that, when they run across the house they are built in the usual way with a top and bottom plate. When longitudinally, or *fore and aft* partitions, as they are usually termed, or run directly over each other, they have the top plate only and the bottom ends of the studding passing through, or between the floor beams and resting on the top plate of the story below, in the manner represented in the engraving, Fig. 7, which is a projected section of an upper story floor, showing the floor beams and plates and studding of a *fore and aft* partition. When the spacing of the studding compels that one or more studs should rest on a beam or trimmer as the engraving

shows, then, of course, it is not possible to pass them through, but they should invariably rest on the plate below and the space between filled in with old or broken brick so as to make the partition semi-fireproof. As I have previously described the methods of centering for the arches between the first story steel beams and other details, I will close this chapter by advising all readers to study the actual construction when in progress, as it is in this way only mechanical information is acquired.

CHAPTER II.

SECOND AND UPPER STORY BEAMS, PARTITIONS AND BRIDGING.

Continuing the consideration of the methods to be followed in framing the timbers for a brick house, I show readers at Fig. 10 the second floor plan of the floor timbers for a house with a splayed or sloping plan on the front of the house, thus necessitating shortening each floor beam as they are spaced out to the acute angle. This

peculiar plan is caused by an avenue not running square or at right angles to the street.

they ought to hold and help to tie the sidewalls together. To the left of this engraving a trimmer arch will be seen to be

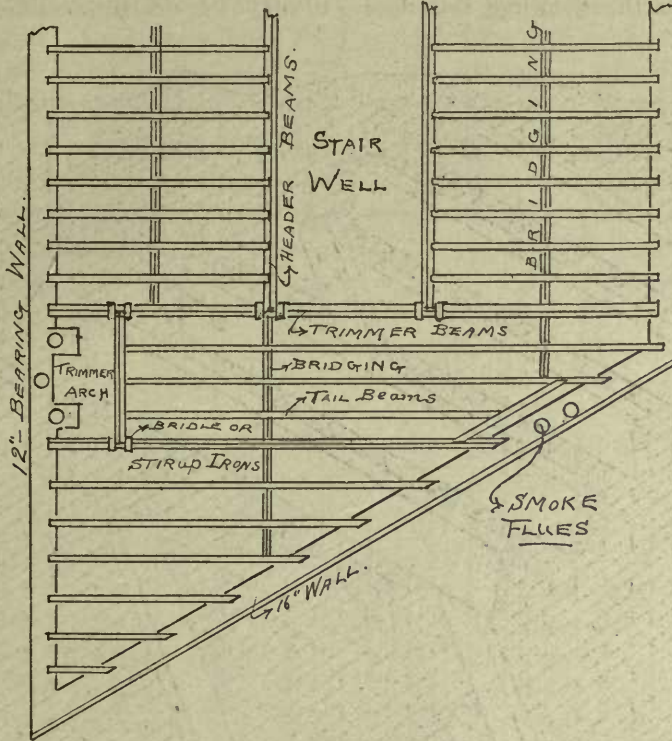

FIG. 10—FRAMING PLAN OF A BRICK CITY HOUSE.

In this case the front anchor strips let into the beams would not be necessary and could be omitted, provided the end T-anchors were placed on every beam and well nailed thereto, thus tying the walls together.

In this engraving I also give a very clear conception of the proper way to proceed in framing round openings, by doubling up the trimmers and headers and hanging the headers in stirrup or bridle irons and framing of the tail beams. All trimmer beams should be thoroughly anchored, and the tail beams should also have some anchors. Some framers claim they are useless on tail beams, but I maintain that if tail beams are well nailed to the headers

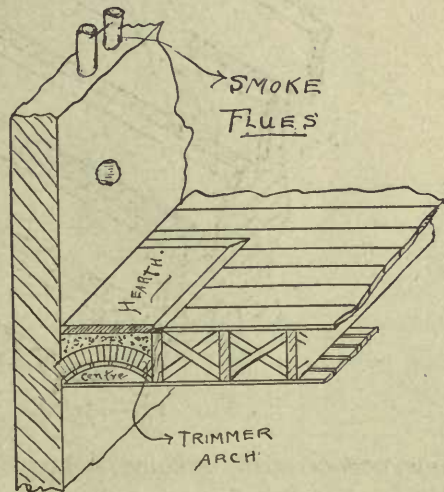

FIG. 11—SECTION THROUGH FLOOR AT HEARTH.

turned with one skewback abutting against a beveled strip nailed to the face of the header in the manner represented at Fig. 11, which is a section taken through the floor at the hearth, showing the floor

arch in the usual way, but is not usually removed or *broken out*, as the material thus saved is not worth the expense of removing it. The object of the *trimmer* arch is to make the hearth incombustible, and con-

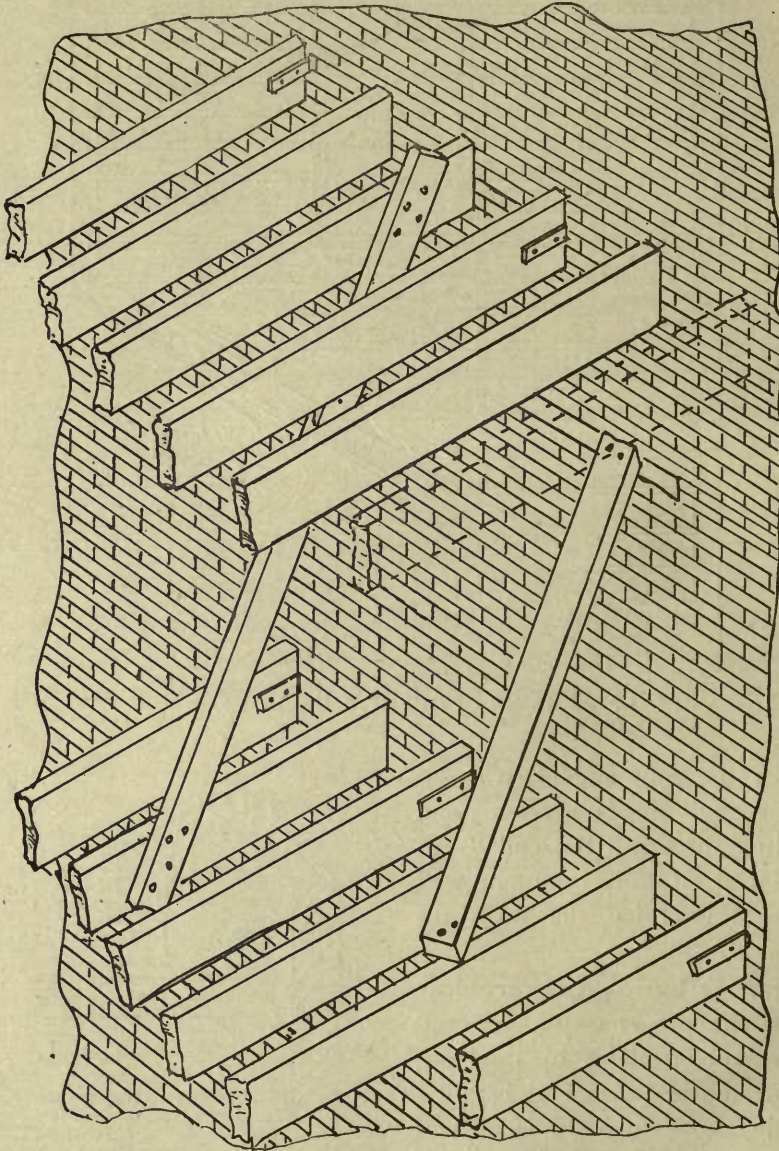

FIG. 12—METHOD OF BRACING BRICK WALLS.

beams, *trimmer arch*, bridging, lathing and flooring, also the flue, and flue linings, which are now inserted in almost all smoke flues. A centre is set for each trimmer

sequently the beams are not liable to catch fire, being so far removed from the smoke flues.

Bridging should be set about every six

feet between bearings, and if possible, for greater stability, should start from the end of a header or against a wall. This is also shown in Fig. 10,

Concerning the bracing of the walls during construction, I would state that the usual method is to build in a piece of 2x4 joist or studding into the inside face of the wall, about two feet below the bottom edge of the tier of beams above, and then nail a 2x4 stud from this built in piece, to the

ful so as not to jar the wall and to break the bond, or strain it in any way.

Another important matter I wish noted is to make up under the ends of all floor and roof timbers solid so as to avoid a spring in the floors, also to do all nailing thoroughly either in partitions or other timber structures.

Fig. 13 shows the best method of *trussing* or stiffening a partition so as to resist weight above or prevent buckling. If the

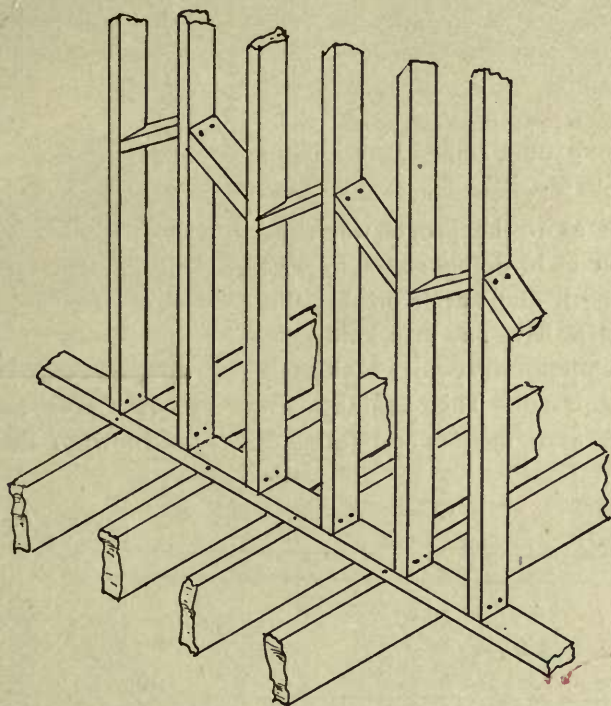

FIG. 13—A TRUSSED PARTITION.

beam on the floor below. I am opposed to this plan, however, and would recommend that the walls be braced from story to story in the way I illustrate in Fig. 12 at back of engraving. I know it is scarcely safe for a framer to walk on, or set beams on a *green* wall, or one with the brick freshly laid, and some bracing is necessary, but strips of wood built in a wall rot out. However, framers and carpenters when setting beams on walls should be very care-

partition be very high, two or three rows should be cut in so as to increase its rigidity and also act as a fire stop. If the partitions are to be filled in with brick they should have the *bridging* or trussing pieces set level, and the bricks laid on these pieces.

I would now ask the reader to refer to Fig. 14, which is a projected view of bridging seen from the floor below. In the floor plans shown in the foregoing engravings,

the bridging is denoted by three parallel lines. Here it is represented placed and nailed to the floor beams.

Much difference of opinion exists

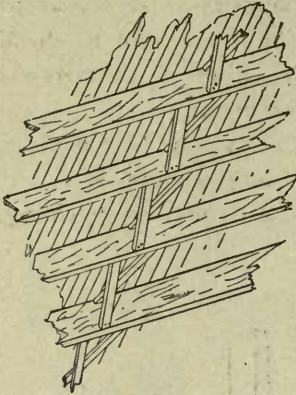

FIG. 14--BRIDGING OF FLOORS AND ROOFS.

amongst mechanics as to the proper way to lay out each piece of bridging so as to get it the proper length and bevels on the edges. Some prefer to have one man hold the long piece up while another saws each piece to the bevel required. This, I think, is a tedious and inaccurate method and not

satisfactory, as the pieces are often sawn too short or too long, and not to the exact

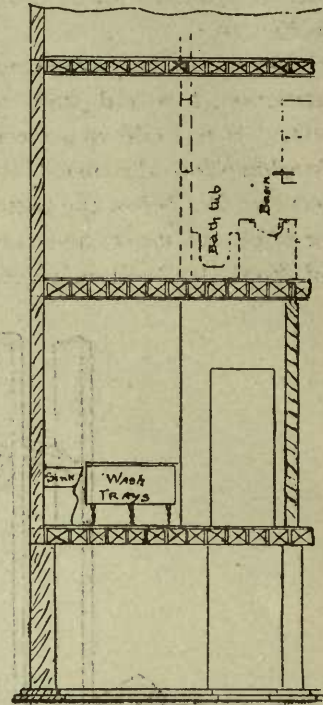

FIG. 15—A CROSS SECTION OF HOUSE SHOWING BRIDGING.

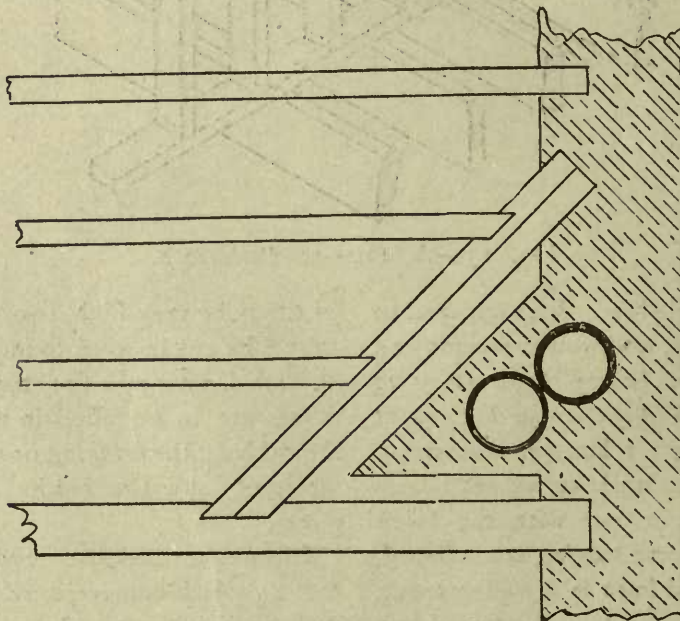

FIG. 16.

level. I would recommend to all carpenters to try the German way, that is, to strike two parallel lines with the chalk line across the top edges of the floor beams at a distance apart equal to the depth of the beams; if they be 8" beams, eight inches apart; if 12" beams, twelve inches apart, and so on. Now, if the bridging be laid across from beam to beam diagonally the exact length and bevels will be given and the pieces must fit, even if the beams be not equally spaced out, and it frequently happens they are not. This method I illustrate at Fig. 9, by the dotted lines and the cross section Fig. 15, where the bridging is shown placed on each tier.

At Fig. 16 I show the proper method to follow in framing trimmer and tail beams connected with an angular header. In this case the header is on an angle of 45 degrees. It will be noticed the header and trimmer are doubled and the header mortised into the trimmer on one end, the other end resting on a brick wall. Great care is necessary in framing headers of this kind and they should never be set in bridle or stirrup iron with a butt joint, as they are liable to slip and the floor to sag as a natural consequence. They should also be

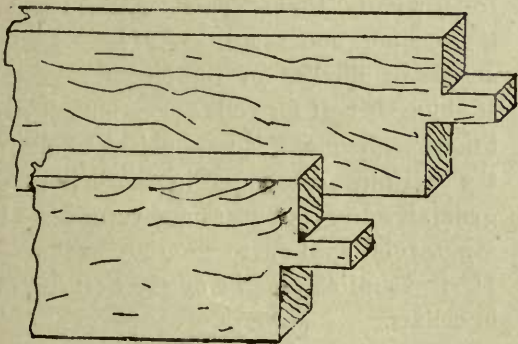

FIG. 17.

framed as represented in Fig 17, a method which I believe to be the safest and most economical existant. The ends are simply mortised and gained together, the mortise

and gain being above the centre breaking line or neutral axis of the beam, thus forming a strong joint without weakening the header.

CHAPTER III.

FIREPROOFING WOOD FLOORS, PARTITIONS AND DOORS.

In connection with floors I would here draw attention to the method of *semi-fire-proofing*, or deafening floors, shown at Fig. 18. It consists of a series of wood cleats or strips nailed about four inches down on each side of the floor beams. On these strips $\frac{7}{8}$ " or 1" boards are placed and nailed, so as to form a shelf or pocket between the floor and ceiling below. These pockets are afterwards filled in with a concrete made of ashes and cement, thus rendering the floor both fire and sound-proof. The writer believes, however, that the water in the concrete is absorbed by the pores of the wood, and after a time a dry rot ensues which is sure to injure the wood, so as to impair its strength and render it unsafe. Care, then, should be taken not to put in the concrete slimy or very wet.

Fig. 19 illustrates the simplest modern method in use for preventing fire from traveling up from one line of lath and plaster partition to that directly over it, above the tier of beams. The scheme is to fill in the spaces between the beams with brick and mortar, in the way represented in the engraving, the brick being laid on the top plate of the partition below. When it is necessary to make a partition entirely fire-proof, horizontal pieces of bridging are inserted, about two or three rows in the entire height, and on these pieces the bricks are laid, breaking joint in the bond, so as to stiffen the whole partition. When the

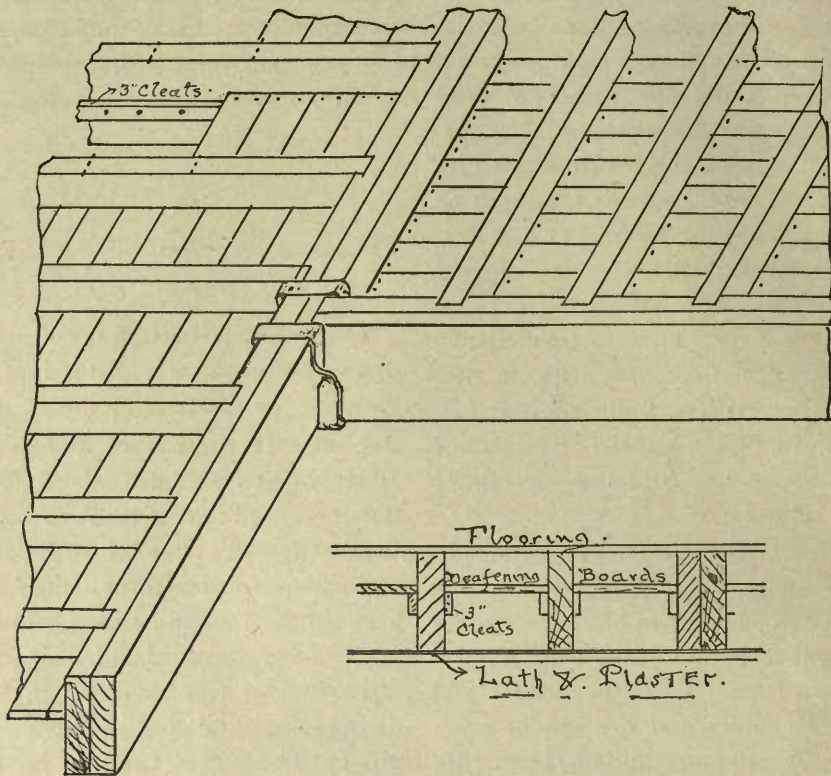

FIG. 18—METHOD OF DEAFENING FLOOR.

partition is constructed of studding set on flat or only $2\frac{1}{2}$ inches thick, the bricks are laid on the top of each other, edge to edge. The horizontal bridging pieces should not be more than 3 feet apart in the height: that is, in a 12 foot partition there should be three or four spaces, in a 9-foot partition two pieces or three spaces, and all the spaces should be a tight fit and well toe-nailed into the studding. If there be partitions in the cellar, and the bottom does not rest on a brick wall, or be carried on stone footings, then a sleeper or plate of *locust*, or other hard wood, should be set into the cellar floor, as locust will not rot. A better plan, however, is to first concrete the cellar, and then set the bottom plate of the partition directly on the concrete and cut the studs in tight. The exact length

of any stud may be found by setting the top plate on top of the bottom plate, and then measuring up to the ceiling with two rods, sliding them apart till they touch the ceiling and plates. An $\frac{1}{8}$ " or $\frac{1}{4}$ " should be allowed for tightening. Spruce studding is best for cellar or basement partitions, as hemlock is too subject to absorb the existing dampness in the cellar and generate early rottenness and vermin. The same rule applies to flooring, yellow or North Carolina pine being the best for use in cellars.

Concerning the usual cheap method of laying the bearers and flooring on top of the iron I beams, forming the first story fireproof floor, I would here state that the common practice is to first cover the brick arches between the beams with a common

concrete up level with the top flanges of the I beams, and then to lay 2"x4" spruce or hemlock diagonally across them, either on flat or edge, tying the ends together with cleats or over lengths of joists, and making sure that all the ends are made up solid so as to prevent their springing. These joists are usually spaced 16" apart and on them the flooring is nailed in the usual way.

Fig. 20 represents the simplest method of constructing a cheap fireproof door. It is made of $\frac{7}{8}$ " tongued and grooved boards

against the face of the wall, by this means leaving an air space between the wall and the plaster. Carpenters should be sure in nailing on furring that the nails draw the furring tight to the brick work and that they hold it firmly. The bottom edges of the floor beams are also often furred, and it is a very judicious practice, as it allows the air to circulate round the beams and prevents them generating a dry rot. The frequent discoloration of paper on walls is caused by the plaster being laid on the brick wall and the heat of the room drawing the damp through stains the paper.

Furring, therefore, should be nailed on all outside brick walls of 12" thick or less, so as to prevent dampness coming into the rooms and making them unhealthy. If

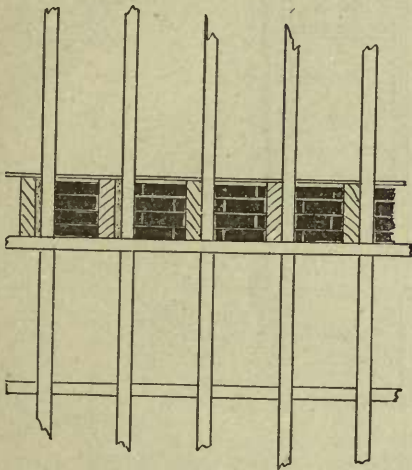

FIG. 19—COMMON METHOD OF FIREPROOF PARTITIONS.

in two thicknesses, one thickness running diagonally. The whole completed door is covered with tin, or sheet iron on both sides and edges, so as to render it incombustible.

Furring is a term applied to wood strips, nailed or spiked to outside brick walls, for the purpose of nailing the plasterer's lath and thus preventing the plaster from absorbing the inherent dampness of the wall. These strips are generally 1x2" or $1\frac{1}{8}$ x $2\frac{1}{2}$ ", and are nailed on vertically and spaced out 12" or 16" as desired. The nails are driven into the joints of the brick-work so as to hold the furring tightly

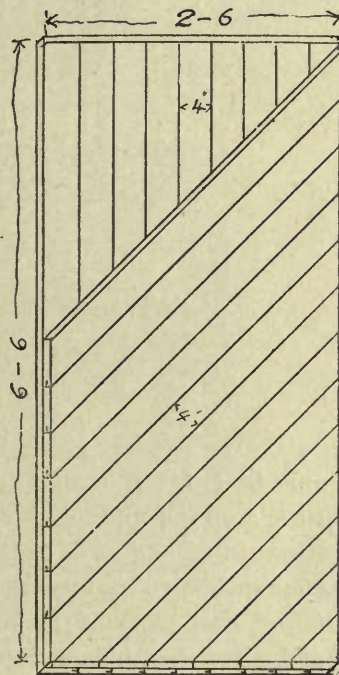

FIG. 20—HOW TO MAKE A FIRE-PROOF DOOR OF WOOD.

hollow bricks be used on outside walls it will not be necessary to put on furring, as the plaster is spread directly on the hollow brick, and this kind of brick makes a very dry inside surface.

CHAPTER IV.

ROOFS, BULKHEADS AND FRONTS.

Concerning the construction of the roof, I might state that the roof timbers are usually placed as the floor timbers below, across the house from gable to gable, with the exception that they pitch so as to form a gutter or gutters in the centre or rear of the building in order to carry off the water, snow, etc., to proper leaders. This, of

permit the ceiling to be *furred down* level. The way builders generally do this is, to hang 2x2", or 2x4" joists from the rafters with 1x2 furring strips or scrap scantling, spaced 16 inches on centres to accommodate the plasterer's lath. Of course, all openings for "Scuttles," which are square openings framed for in the roof, must be allowed for, and constructed according to the methods I have described for floor openings in the preceding sections of this arti-

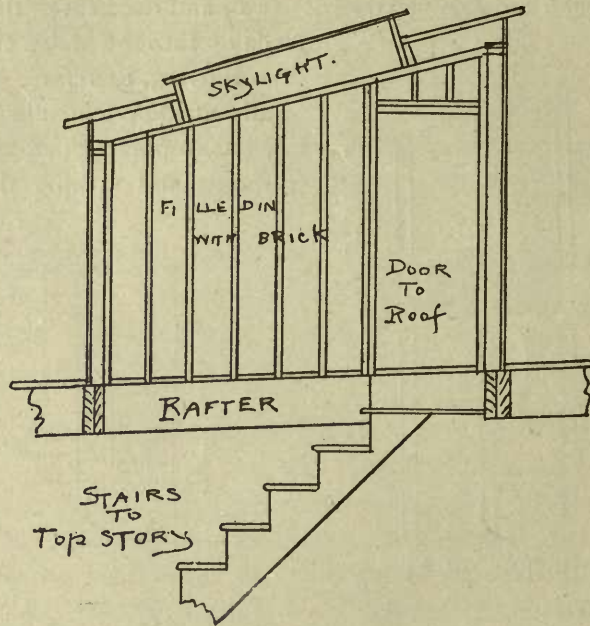

FIG. 21—SECTION OF BULKHEAD.

course, must be done by pitching the beams as they are spaced out, and the best method is to set one front and one on rear, and stretch a line through so as to get a straight roof surface. Flat roofs of the kind used in cities and covered with tin will drain dry, with a pitch of 1 or 1½ inches to the foot. The roof beams are generally bridged and kept up sufficiently high to give a level ceiling on the top story under them. For example, if the top story is 10 feet in the clear of the ceiling, then the roof beams are kept 1'-6", or 2'-0" high, so as to

cle, and the headers, etc., properly hung in bridle irons

Similarly, if there be, and there usually are, any fore and aft partitions on the top story, the top or upper-plate of these partitions must be against the under edges of the rafters to support them in the middle of the span and prevent their *sagging* or deflecting.

Regarding next the construction of bulkheads. I would say that these are a sort of box or small, framed structure placed on the roof over the stairs which lead from

the top story to the roof. I show a section of a bulkhead at Fig. 21. It is formed by framing an opening in the roof equal to the area required for the stairs and required

and raised with the necessary wall-plates for the roof of the bulkhead. The roof has generally plenty of pitch and is framed for a skylight to light the entire stairs from the roof. There is also a door opening allowed on one side, generally the southwest side, to permit egress to the roof. This method is much better in city houses than the usual scuttle and iron ladder, because it gives easy access to the roof and permits of its use for drying clothes, air, etc.; but it must be remembered that the friction of the feet in walking is ruinous to a tar and gravel or tin roof, and proper gratings should be placed over the roof covering to preserve it from injury. Bulkhead studding is filled in with brick and covered with boards and metal to make it fireproof, and the door is made in the way illustrated in the last chapter.

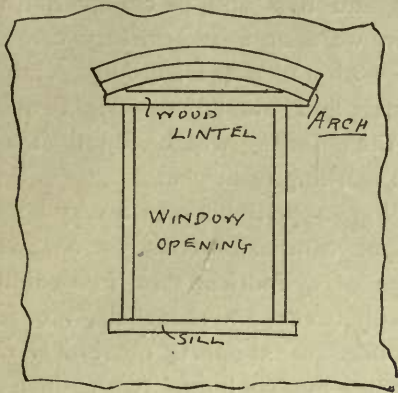

FIG. 22—WINDOW LINTELS.

head-room, the framing being done as in the case of floors, namely, the trimmers and headers being doubled and the headers hung in bridle irons, on these around the opening or well-hole studding are framed

I have now led this subject up from the first floor to the roof, so I will here give

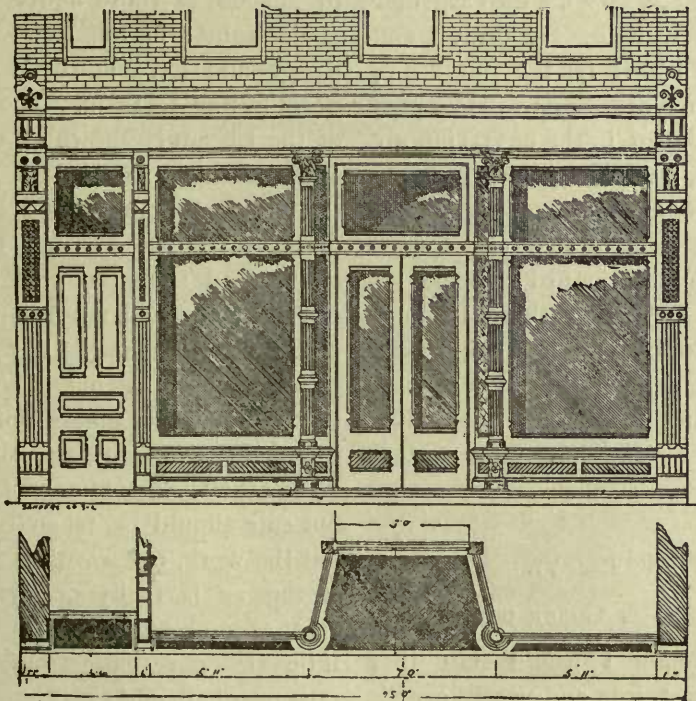

FIG. 22-A—ELEVATION AND PLAN OF STORE FRONT.

Some general instructions about miscellaneous details to be attended to. The carpenter or framer may be called upon to set the window frames, and as this is a comparatively simple matter, I will not comment upon it except to urge the absolute necessity of getting all frames perfectly plumb, square and out of wind, and to have them all well braced back to the beams so that the mason or bricklayer may not jar them out of position. The carpenter will also be obliged to furnish the mason with all the wood lintels to be placed at the back of the stone lintels he may require. These are used to span the width of the door or window opening and to form a centre for the arch which is turned over them. They are made of 3"x10" or 3"x12" plank, and are beveled on the ends as shown at Fig. 22, with 4 inches of bearing on each jam. Where the front is of iron columns and girders as seen in Fig. 22-A, it will be necessary for the carpenter to see that screw holes are drilled and tapped in the iron work for the purpose of fastening the iron work thereto. The plan and elevation shown in the engraving are self explanatory, so that any carpenter can understand how necessary it is to be familiar with the modern methods of constructing city houses in order to be up with the times. Another thing I would call attention to before concluding, and that is the methods of fire-proof floor construction given in the foregoing engravings in order that all may be thoroughly posted.

CHAPTER V.

WOOD AND IRON CONSTRUCTION.

In the beginning I would state that wrought and cast iron and steel have almost entirely displaced timber as posts and columns, and in some cases floor beams,

especially in cities and the large towns, where stringent fire laws make their absence conspicuous in office or warehouse buildings, but they are still used in dwelling houses and flats and, in conjunction with iron, in warehouse and factory construction. With a view therefore of giving the carpenter and framer an insight of this work, the following will be found of value even if working from plans.

At Fig. 23 will be seen a very fair example of composite construction, which consists of cylindrical cast iron columns, cast with bases and brackets, the latter being used as supports or rests to carry on the basement columns, two 12-inch steel I beams bolted together and kept together (to act as one) by cast iron separators. The ends of these I beams are bolted to lugs cast on the columns in the manner seen in the side view at Fig. 23. The first story columns, not having so much weight to sustain as those above, are generally made lighter in the metal and of better design, and have in this case but one I beam bolted to them. The sectional end of the I beam is shown on the front view, and the side as bolted to the column in the end view; timber floor beams may be placed on these, crossing them at right angles and spread out at 12 or 16 inch centres, as desired, according to the weight placed upon the floor. For ordinary stores or warehouses sustaining a weight from 150 to 250 pounds per square foot, the construction here given with the columns, spaced 10 feet between centres will be sufficient; but care should be taken to design or lay out the work, not less than three times as strong as is really necessary. The old rule of making every construction—"A little stronger than strong enough,"—is now obsolete, and every structure must be carefully and accurately calculated, and put together so as to be in perfect equilibrium

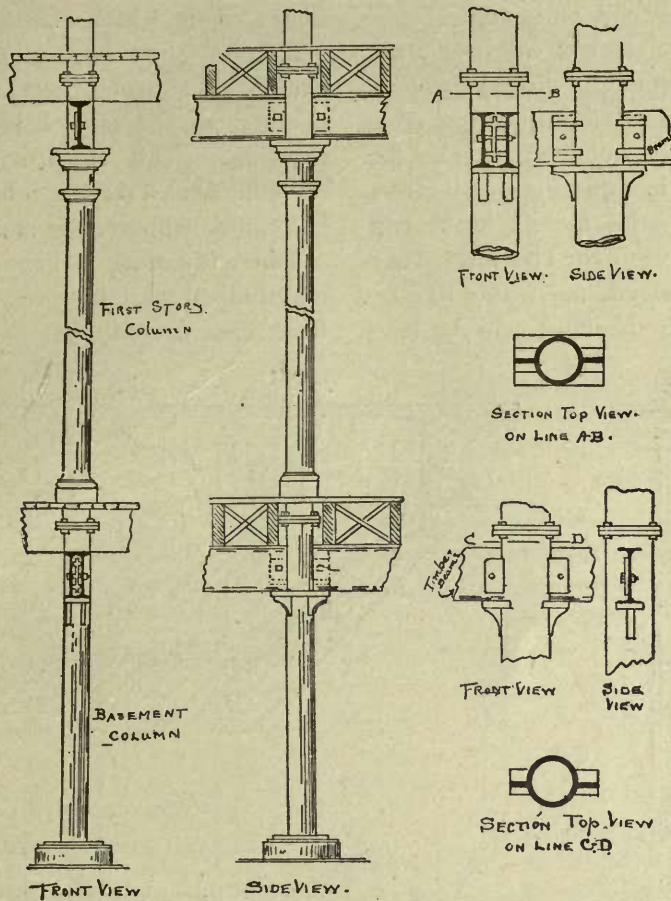

FIG. 23—ELEVATIONS AND DETAILS, WOOD AND IRON CONSTRUCTION.

and free from liability of collapse. From the above description and a close study of Fig. 23, any intelligent mechanic will be able to grasp the details of this form of wood and iron construction.

Where well-holes for stairs, trap-doors, hatchways, or skylights occur, according to the exigency of the plan, they have the header and side beams doubled, the headers and tail beams being mortised, tenoned and joggled together and hung in a *bridle* or *stirrup* iron seen in the engraving Fig. 24. This useful appendix in framing is a $\frac{5}{8}$ " or $\frac{3}{4}$ ", x 2" wrought iron strap so constructed that it hangs or hooks over the trimmer or headers and sustains the headers or tail beams so as to add to them

additional strength to the beam. The writer prefers not to mortise the tail or header beams, but to simply abut them against face of the beam and spike it solidly there-

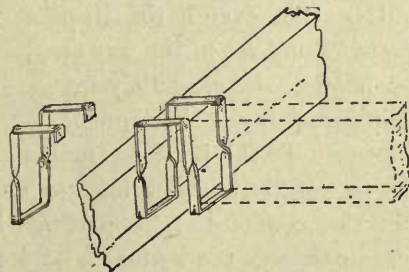

FIG. 24—STIRRUP IRONS.

to, believing that the stirrup is sufficiently strong to support the beam without weakening the header to which it is attached.

The illustration Fig. 25, will convey to carpenters the method of laying sleepers on bearers in concrete laid on top of brick or terra cotta arches in fireproof floors. These floors are now entirely employed in so-called fireproof buildings, in the first floor of flats and in engineering structures. The 4x4 or 3x3 strips are set in the concrete above the level of the I beams. These must be set level and fair with a line and straight edge so the floor will be level.

can be clearly understood in a few minutes. Fig. 27 is the Fitch Plate girder made up of two or more timber beams, having a plate of rolled iron or steel sandwiched between them, the whole being solidly bolted together. This construction is not so economical as a steel or rolled iron I beam, but can be employed in some cases.

I here illustrate, in Figs. 28 and 29, the longitudinal and transverse sections of a floor made up of timber beams, resting on

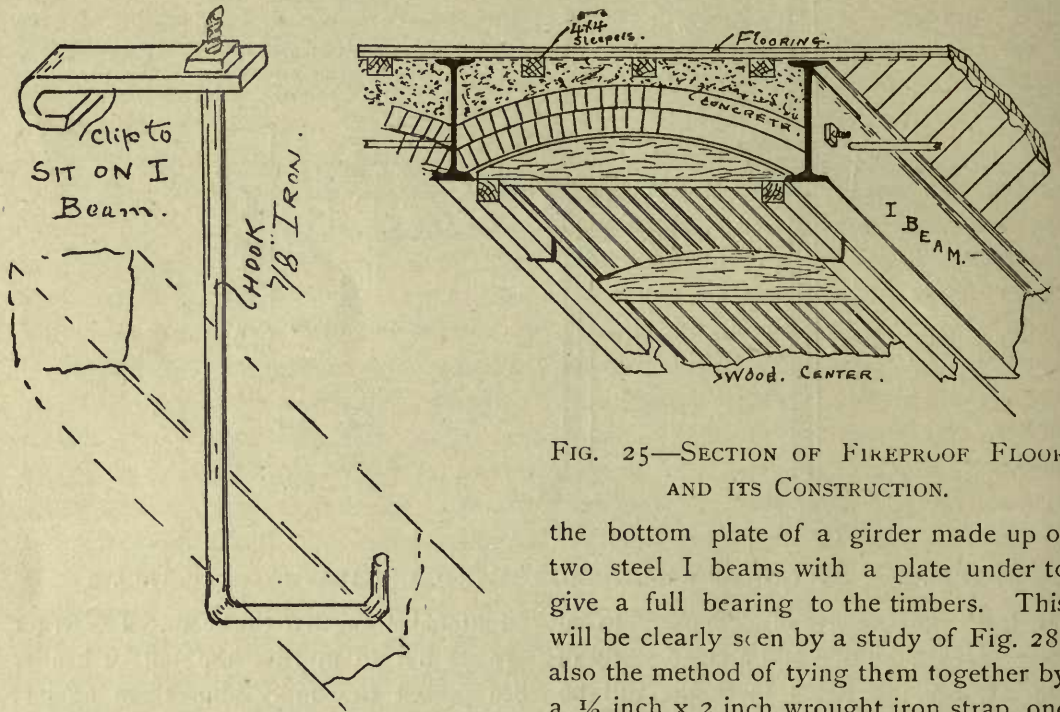

FIG. 25—SECTION OF FIREPROOF FLOOR AND ITS CONSTRUCTION.

the bottom plate of a girder made up of two steel I beams with a plate under to give a full bearing to the timbers. This will be clearly seen by a study of Fig. 28, also the method of tying them together by a 1/2 inch x 2 inch wrought iron strap, one

The writer is much opposed to this method, because even if the strips be dovetailed and set in the wet cement concrete, where, as they dry, they will invariably shrink and become loose. To this is added their liability to rot from absorbing the dampness in the concrete. For placing these sleepers or bearers the writer has adopted the method represented at Fig. 26, where they are wedged fast and, being above the concrete, cannot rot or be affected by shrinkage. The construction of this form

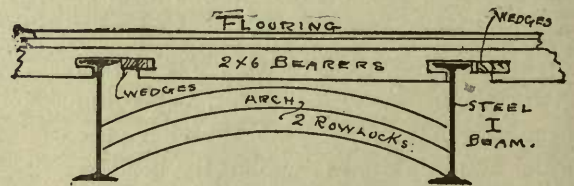

FIG. 26—SECTION SHOWING METHOD OF WEDGING BEARERS.

of which passes over the top of the girder on one beam and under it on the next one, or on every second beam, thus tying the timbers together on each side of the girder,

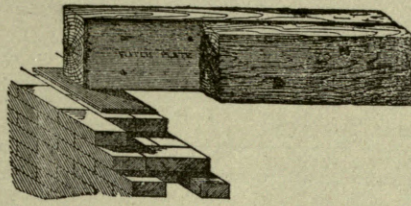

FIG. 27—FLITCH PLATE GIRDERS.

by being thoroughly spiked to each beam. The beams are fully fitted so as to have a good bearing on both ends, and bridged with double rows of bridging in each span.

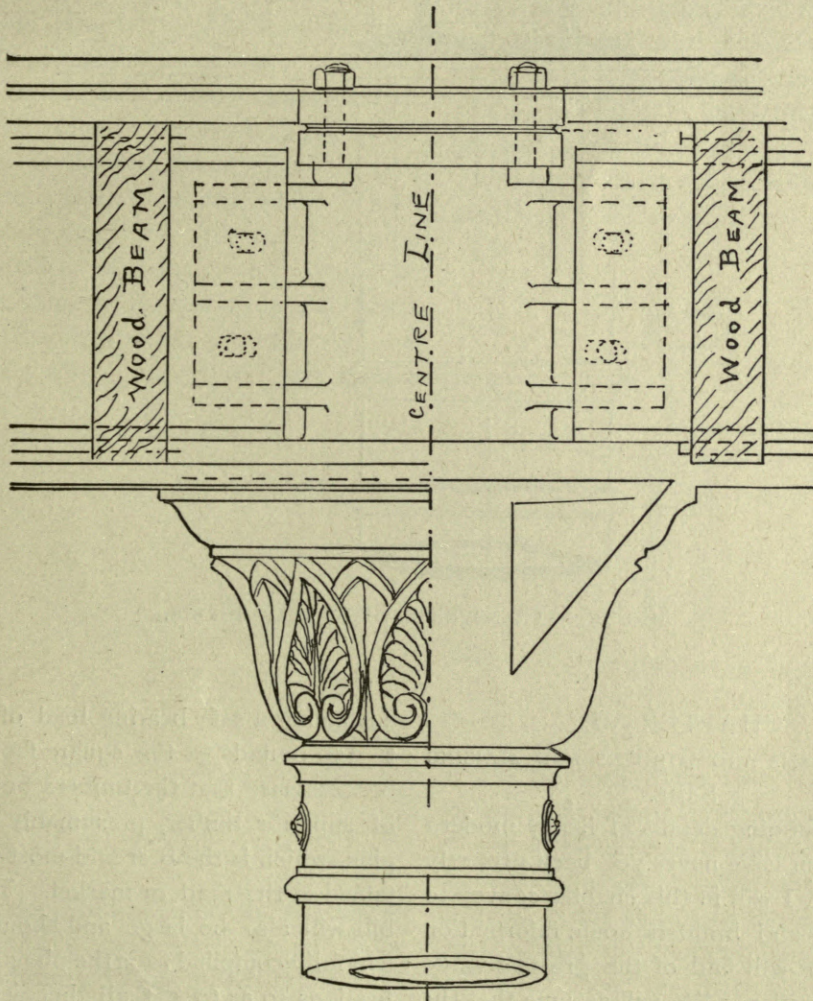

FIG. 28—LONGITUDINAL SECTION OF FLOOR.

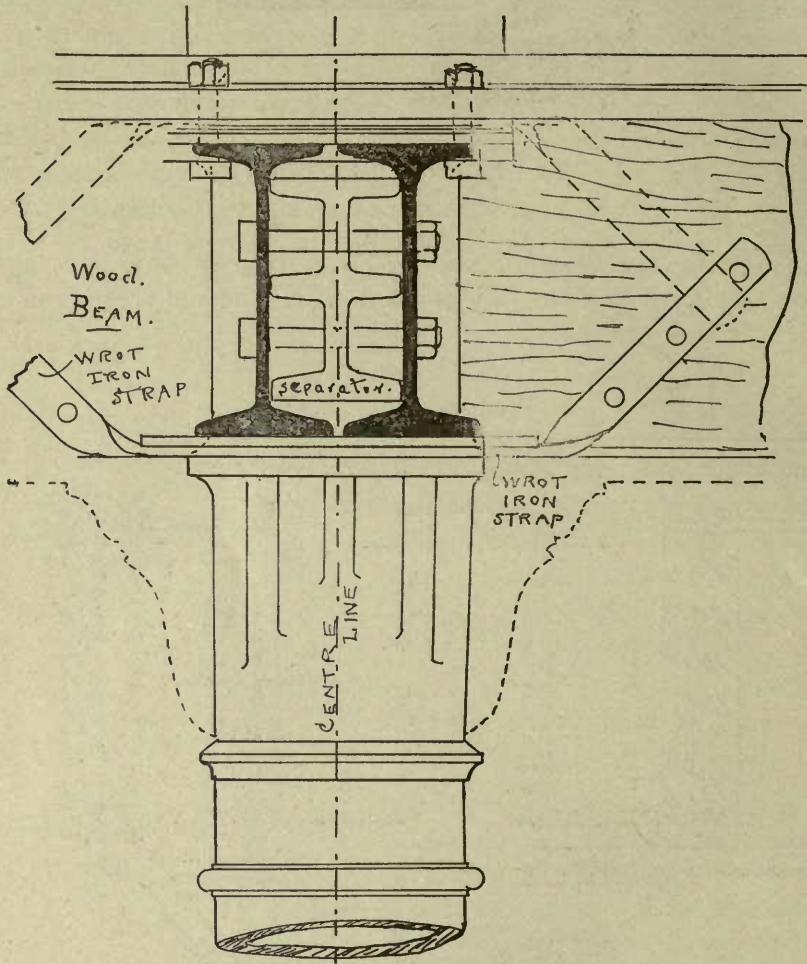

FIG. 29—TRANSVERSE SECTION OF FLOOR.

CHAPTER VI.

HEAVY BEAMS AND GIRDERS AND RAISING SAME.

As the framing details of heavy modern construction have never yet been properly considered, I will in this chapter convey to carpenters and builders some information which they will find of the greatest value in their practice. We will assume that the Figs. 28 and 29 is requisite for a large five-story stable or warehouse to be capable of

sustaining a safe bearing load of from 200 to 250 pounds to the square foot. It will be necessary that the timbers be large and of superior timber, presumably of yellow pine, which is the best and most easily obtained in the modern market. The timber bill will also be large and should be very carefully compiled from the plans and specifications so as to get all the pieces on the job. To this end a list should be made out, each item being under a separate heading

with the quantities required for each length, etc., as

Girders,
Posts,
Floor Beams,
Roof,
Braces,
Studding.

With this list and a framing plan any skilled carpenter or framer may lay out, frame or raise the timbers for a heavy job. I would state here that the framing plan should be furnished by the architect, and it usually is a plan of each story with the girders and floor beams, the headers, trimmers, etc., shown on it so that it is a map or diagram of each timber required and an invaluable guide to the foreman mechanic. In regard to the actual framing of the timbers there is little to be said which I have not already described, with the exception that the form of construction should be stronger than those previously published, and for the instruction of readers I now show them why. Fig. 30 will give an idea

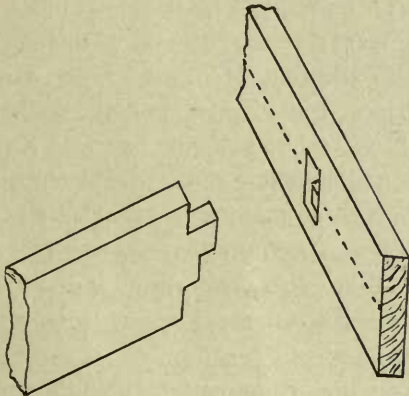

FIG. 30—A TUSK TENON.

of a stronger form of tenon and mortise for 3"x10", 3"x12", or 3"x14" or 16" floor, tail and header beams where bridle irons are not used, and care should be taken to have the tenon and mortise above the neu-

tral axis of the timber as shown in the sketch by the dotted line. This "tusk" tenon gives great strength and may be used with advantage on 3", 4" or 6" floor or roof timbers, where there is a short header as that framed around a chimney; but if the header be over six feet long, I would recommend that the tenon be omitted entirely, and each tail or header beam hung in bridle irons, as I described in a previous chapter.

A word more in regard to main supporting girders. Recent experience has shown me that the best way to join them over columns is to simply abut them together, end to end, and insert double end T-anchors to tie them together, or, if the bearing surface be not large to halve them with a simple half, as in the case of a sill or plate. The form of construction, which I illustrate at Fig. 31, will explain my preference, as

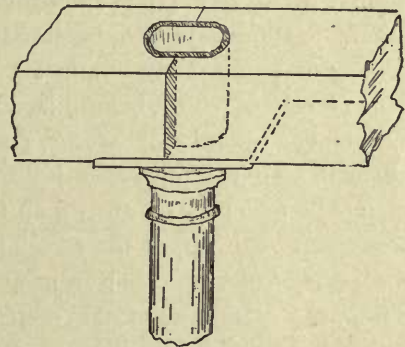

FIG. 31—FRAMING OF A GIRDER AROUND AN IRON COLUMN.

it will be seen there that the girder has its ends of the two lengths mortised out to fit one of the sleeves of the columns, thereby weakening its strength where it is most needed, but it had to be done here for the reason that the vertical line of cast-iron columns rested on each other from story to story, the whole being carried by a heavy brick pier in the cellar. A halved

horizontal joint with cast-iron or oak dowels inserted in its inside face is, where possible, the best for girders.

Similarly with wooden posts or columns of any dimensions, of more than 24 square inches of area on top and bottom ends, the mechanic will invariably find that the best construction is to cut them square (bare foot) and insert two or three dowels to keep them from slipping sideways. I may here say that architects are realizing that the mortise and tenon system sacrifices the strength of the piece mortised to that of the piece tenoned in constructive framing, and are equalizing the loss by the adoption of the dowel which the mediæval and ancient framers used with the greatest success.

Regarding the raising of heavy beams and girders, I would state that this operation demands apparatus, and also skill on the part of the framer. The apparatus or appliances can be readily made of wood, and are indispensable for the safe handling of timbers too unwieldy to be lifted by hand. The first and most important are the ordinary rollers which, being placed on inclined planes of planks or beams, enable the mechanics to roll up heavy beams or girders on the first floors from which they are hoisted to the upper floors. These rollers should not be less than from 4 to 6 inches in diameter, and be of oak, maple or some other hard timber not liable to crush, bruise or splinter. They may be of any handy length, say from 2 to 4 feet long, so as to be easily handled. A very excellent roller for use on the floor beams is that shown in the engraving Fig. 32. As will be seen, it is simply a roller set in a frame, so that the frame spans three or four floor beams, and heavy timbers can be rolled on it with greater ease than with a common roller on planks. The use of rollers is, as the reader will understand, of the greatest necessity where timbers weighing from 600

to 2,500 pounds have to be moved on floor beams freshly set in green brick walls.

When the timbers are on the floor they will next be raised or hoisted into position, and this may be very conveniently done with the aid of the improvised derrick represented at Fig 33. It is made up of a T

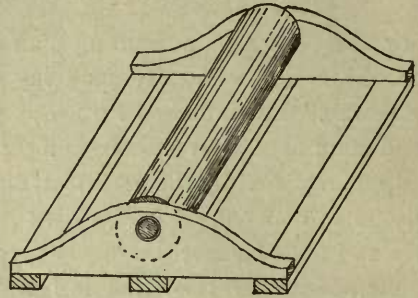

FIG. 32—ROLLER FOR USE ON FLOOR BEAMS.

sole or base formed of two 3"x8" or 3"x10,' timbers bolted together, and on these are raised two uprights or standards of 2x4 or 2x6 spruce joists slightly pitched forward. To these, two braces are bolted from the shank of the T to the top. On the uprights a windlass with a pawl and ratchet is bolted. With the usual block and tackle lashed to the top end of this derrick and the addition of 'guy' ropes, almost any heavy timber girder may be safely raised. If the mechanic is afraid his uprights might buckle under the strain of the weight, he can nail horizontal cleats across their edges, spacing out the cleats 12 or 14 inches apart, so as to form a ladder to get up and make fast the guys or blocks and tackle.

A very important matter which the framer should guard against in raising and placing heavy timbers on a new building is, to avoid jarring the green walls by handling the timbers too roughly. This must be especially guarded against on the upper stories, and the girders and wooden or iron columns or posts must be securely braced,

both transversely and longitudinally, before commencing to place the floor timbers. When there is a wide unsupported span of

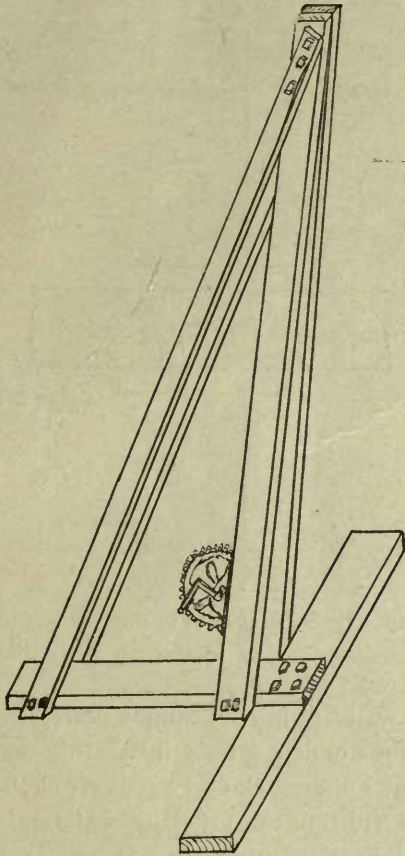

FIG. 33—AN IMPROVED TIMBER DERRICK.

timber, say over twenty feet, a temporary top and bottom plate and a few good studs should be placed under the centre of the span, to prevent their springing when weighted and thus avoid jarring the walls. I am very much opposed to the practice of omitting timbers or series of timbers, leaving them out for the purpose of leaving wells for hod-hoisters or such like purpose, as I believe such omissions leave weak spots in the brick walls, as they need to be thoroughly tied when freshly laid or green. All straps, irons and ties, and anchors should be put in as soon as the timbers are

placed, and be very carefully fitted and thoroughly nailed in order to avoid the possibility of a high wind or any other strain pulling them apart. If the anchors should not be on the job then temporary hardwood straps may be nailed on, but they are only a makeshift and should be done without by ordering the irons early. To omit putting the strap anchors on the longitudinal girders is a criminal proceeding, especially on a high building or when the girders have a square butt joint. In conclusion I can't say too much to carpenters, about taking the greatest care in the details of their heavy framing, so as to avoid all danger of collapses or accidents, which are full of menace to the lives of mechanics and mean loss of reputation and money to all interested. In order to explain what precedes, the following will be useful to those who do heavy framing or work on city house framing. They are most economical and any foreman will have no difficulty in laying them provided he be careful in measuring. The sketch, Fig. 34, illustrates the

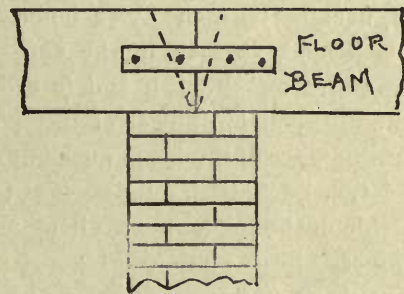

FIG. 34—A STRAP ANCHOR NAILED ON.

proper method of tying floor beams end to end where they rest on a party or intermediate wall. It simply consists of a $\frac{1}{4}$ inch by $1\frac{1}{2}$ inch wrought iron strap tie or "strap anchor" as some mechanics term it, with holes for inserting nails. This is usually nailed on every fourth or fifth pair of beams, thus tying the houses together on every tier and increasing the strength

of the brick walls which would naturally fall under lateral pressure such as wind or strain were each not *anchored* or tied to that opposite. In some cases the ends of the floor beams are beveled, as seen by the dotted lines in the illustration. This is done so that in case a fire occurs and the beam falls, it will fall clear, without acting as a lever to overturn the wall above it.

The next illustration, Fig. 35, is a very excellent and economical way to join two abutting girders end to end so as to form a

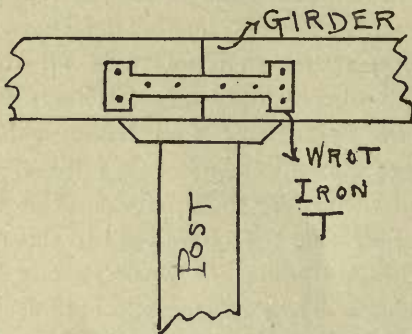

FIG. 35—A DOUBLE T STRAP ANCHOR.

continuous girder. It is made the same way as the foregoing, and is of heavier metal, usually $\frac{1}{2}$ inch by 2 inches wide with a T end, as seen in the engraving. It is, for greater strength and in order to get the full retaining power of the T ends, let into the face of the beam flush and there nailed, thus making, if one be inserted on each side of the joint, an excellent anchor and a very cheap method of construction as there is no framing called for, the ends being simply sawn square and the strap anchor inserted and nailed.

The illustration, Fig. 36, is another economical manner of joining girders. It consists of the old-fashioned half or scarf with two *dowels* of iron placed in holes bored to receive them so as to prevent the timbers forming the girders from pulling apart. Under and over the girder a *bolster* of hard wood is placed to receive the

thrusts of the posts. This makes a very good form of *tie* at the joint, though the writer prefers the strap T anchors, as there is no liability of the joint splitting should

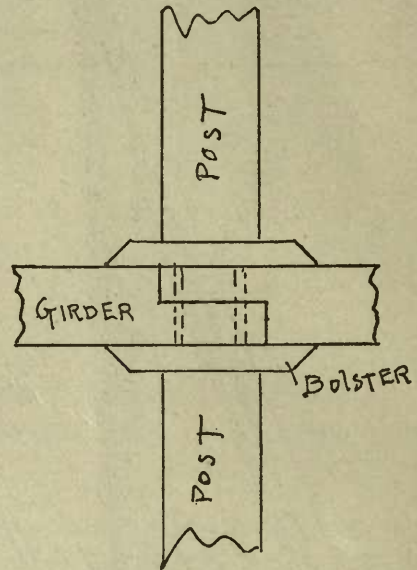

FIG. 36—A HALVED AND DOWELLED JOINT.

the walls bulge. I might state, the very heavy wooden girder in a store or warehouse building should have *star* anchors to pass entirely through the wall and there be tightened with a nut.

Let us here, in connection with framing of heavy timbers, impress on every carpenter the importance of being familiar with the proper knots for tying and fastening his ropes to the timbers when lifting them up. As I have seen in many journals some unusual knots which, to my mind, are not reliable unless made by a sailor, rigger, or some one thoroughly accustomed to ropes, I would recommend carpenters to stick to the simple timber hitch, which is made by passing the rope once around the timber, taking one turn on the rope and twisting it as seen in the sketch, Fig. 37. If it be necessary to lengthen a rope or join two pieces' end, the simple reef knot shown at

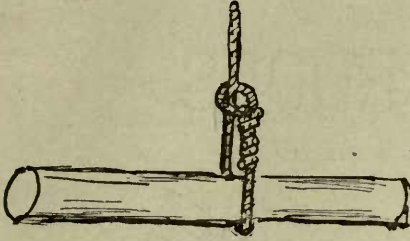

FIG. 37.

Fig. 38, may be used, but all knots should be absolutely certain and sure to hold to

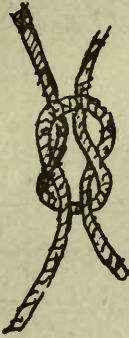

FIG. 38.

avoid accidents. I have seen several men killed by poor knots, and if one is not sure he should turn the job over to some man who can make a reliable knot.

I have been noticing lately the difference between the ways by which various builders and foremen take care of their stuff as it comes to the job, and have been seriously impressed with the results thereof. I find that the usual method is to dump sawn timber carelessly in any place close to the job, letting the timbers lie as they fall, in any position, without properly stacking them, and the result is very injurious to the material. Sawn framing timbers should be put into piles at once, for, being green or unseasoned, if it is piled with one timber bearing on its fellow, the one underneath will become twisted, will crack and warp so as to be unfit for bearing purposes. In stacking, if it is to lie long on the ground strips should be placed between the ranges so as to allow the air to circulate through them and help seasoning.

PART III.

FRAMING ROOFS.

COPYRIGHT 1893 BY OWEN B. MAGINNIS.

INTRODUCTION.

IN COMMENCING these chapters on the framing of difficult roofs, I do so with the assurance that readers will find them valuable, in being able to apply them practically in their work and to any of the intricate roof problems which may be brought before them. I will endeavor to make them as clear and comprehensible as is possible with the subject, so that any roof timbers may be laid out by referring to one or other of the roofs described. No ordinary roofs will be dealt with in order that the chapters may cover a field hitherto untouched by previous writers. Though the descriptions may be entirely new, it will be necessary for me to embrace in them the fundamental principles of geometry which invariably control all mechanical operations.

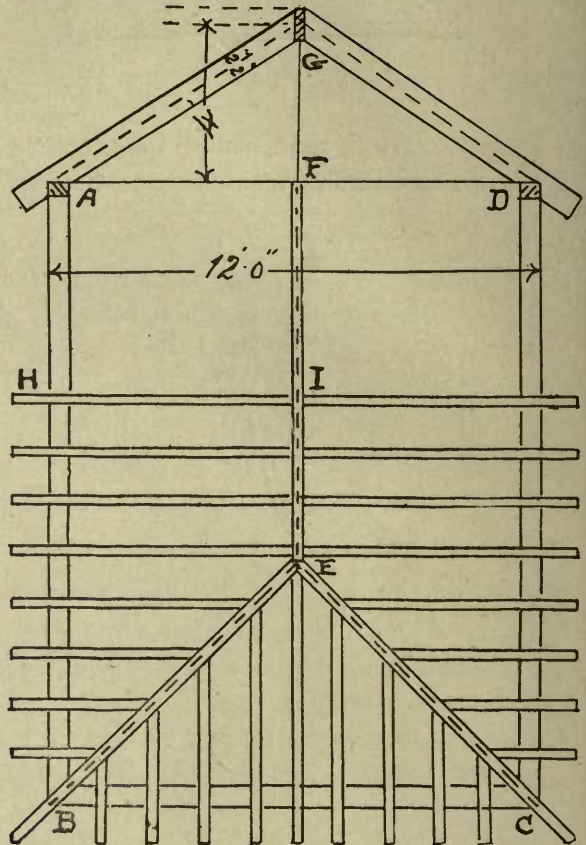

CHAPTER I.

LAYING AND FRAMING A SIMPLE ROOF.

Let A, B, C, D, Fig. 1, be the plan of the wall plates. A D a gabled end, and B C a hipped end of the building, which is to be framed and raised as represented at Fig. 16, for the hipped end, and Fig. 7 for the gabled end. The roof is 12 feet wide to the outside faces of the wall, and the rise or *pitch* 4 feet or one-third the span. The dotted lines denote centre lines.

To lay out the gable end produce the centre line of the ridge E, I, F to G, and from F measure up 4 feet, join G, A and

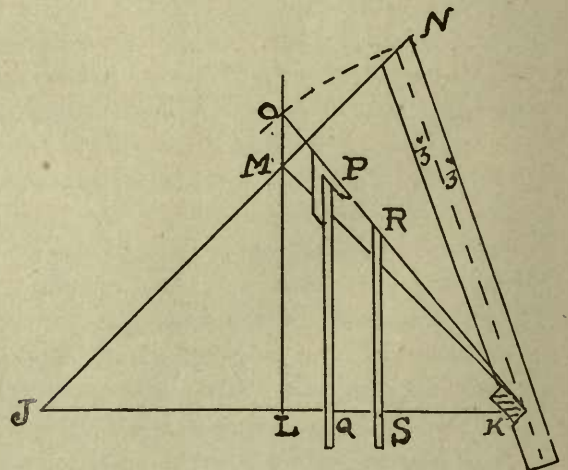

FIG. 1—PLAN AND LAYOUT OF A SIMPLE ROOF.

G, D. Now set off on each side of the dotted line shown, the width of the rafter, 2 inches on each side for a 4-inch rafter, and 3 inches on each side for a 6-inch rafter as shown on the top of Fig. 1, deduct half the thickness of the ridge, half inch, from each rafter peak, cut also notch out for the cut on the plate. All the rafters from F to E will be framed thus.

For the hip rafters, take the distance B, C, and transfer it to J, K, divide it into two parts 6 feet at L, and square up as L.

lengths of the jacks will be to the line O, P, R, K, and their side level will be as P. The bottom notch will, of course, be as at A or D; K shows the bottom notch for the hip rafters and N the peak cut.

CHAPTER II.

HIP AND VALLEY ROOFS.

The first roof which I produce is one of the hip and valley class, or a main rec-

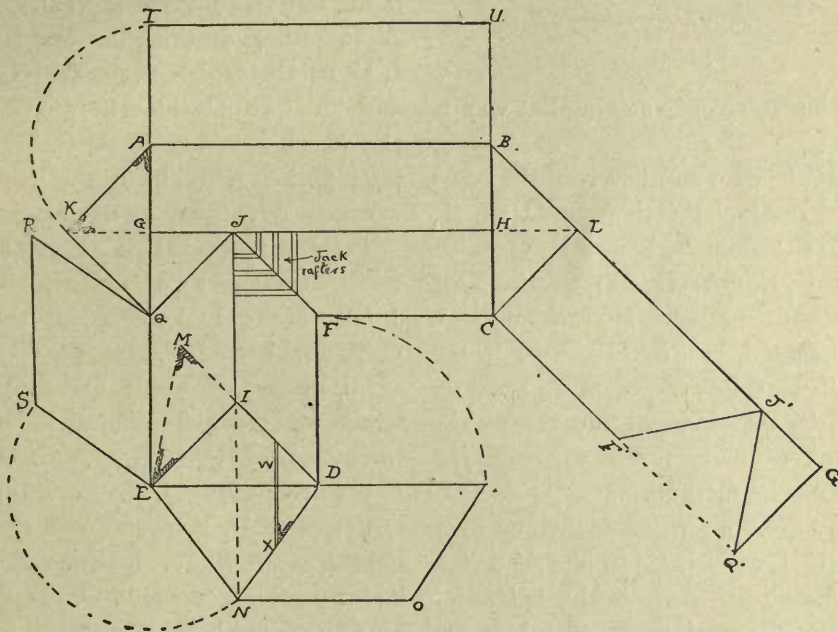

FIG. 2.

M, O. Join M, J, and M, K. Produce J, M, to N, (dotted line,) and join N, K. N, K, will be the centre line length of the hip, and the width may now be set off on each side of it in the manner shown in the diagram.

With K as centre and K, N as radius, strike the arc N, O, cutting L, M extended in O. On L, K lay off the jack rafter as Q, P, S, R, etc.; equally spaced and square to the wall plate (not askew as I have drawn one jack in Fig. 1). The exact

tangular building with an L or addition. A, B, C, F, D, Fig. 2, is the plan of the building and the outside line of the wall plates. The roof is of half pitch or square pitch, as some mechanics call it, which means the height of the roof is equal to half the width of the house. The house has two gables, one on each end of the main part with a hip on the L, and the intersection of the L roof with the main roof produces two valleys. E, I, D, is the plan of the hip, and E, I, D, is the eleva-

tion of it shown on the elevation below, Fig. 3, where the general view of the constructed roof is shown. Q, J and J, F are the valleys on the plan.

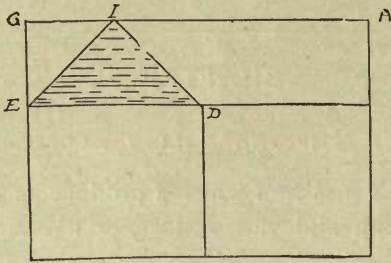

ELEVATION.

FIG. 3.

In framing this roof, the simplest way is as follows :

To obtain lengths and bevels of the common rafter, produce the ridge line G, J, H, to L and K. Join A, K and K, Q; also B, L and L, C. A, K will be the neat length of the common rafter, if no ridge board is inserted, but if there be a ridge board, half its thickness must be sawn off the length on the bevel for the cut on the plate. Any ordinary mind will see the simplicity of this method.

For the hip rafters which will stand over the seats E, I, and D, I, produce the line D, I, to M, and set off on it the height of the pitch, I, M, equal to K, G. Join M, E; M, E, will be the exact length of the hip rafter required, and the bevel at M, will fit the top cut. In regard to the cuts for the jack rafters, which run up the hips and valleys, it might be said that the top cuts against the ridges for the rafters which run up the valleys, have the *top cut* same as the common rafter top cut. The bottom one which nails against can be readily determined by the following simple method: Produce the ridge line J, I, to N, and make D, N, and N, E, equal to M, E, the length of the hip. W, is the jack on its seat or as it will appear in position. X,

is the exact length of it from the plate line to the hip, and the bevel at X, will be the exact bevel for all jacks both on hips and valleys, being reversed for different sides, right and left hand.

The plumb cut of the jacks will be half pitch, or on the steel square, 12 and 12.

In order to prove the exactness of this method of laying out such a roof, we will proceed to develop its planes or sides.

As the rectangular plane, A, B, G, H, take a pair of compasses with a pencil point, and with A, as a centre, and with A, K, radius, describe the arc K, I; draw I, U, parallel to A, B, produce G, A, to I, and H, B, to U, this will give A, B, U, I, the exact covering of A, G, H, B, on the pitch C, K; A, K, being the length of the common rafter with its necessary bevels.

For the plane J, H, C, F, produce B, L, to G', and draw C, F, Q, parallel to B, L, J, G'. Make L, J, G', equal to H, J, G. C, F, equal to C, F, also F', Q', equal to Q, F, make J, F, and J, Q, equal to M, E, which will complete the plane or surface to cover G, J, H, C, F, Q, on the plan.

For the plane J, F, D, I, take D, as centre, with D, F, radius, and describe the quarter circle F, P. Produce E, D, to P, and through P draw P, O, parallel to D, N, also through N draw N, O, parallel to D, P. D, N, O, P, will be the developed covering, and Q, R, S, E, is similarly found.

B, L, C, and A, K, Q, are the gables.

Now if this roof be laid out on a piece of thin wood or stiff bristol board the roof can be folded over by cutting entirely through the following lines: Cut from K to A, A to I, I to U, U to B, B to I, I to G', Q' to J', J' to F', F to C, C to F, F to D, D to P, P to O, O to N, N to E, E to S, S to R, and R to Q. Also make a slit half way through the thickness of the board, from Q to A, A to B, B to C, C to

I, D to N, D to E, and E to Q. By folding the sides or planes over, the exact roof will be seen, thereby proving the exactitude of the methods used. This plan will be the base or plates.

deck is formed on the top, or, more properly, two ridges are needed, one for each

CHAPTER III.

ROOFS OF IRREGULAR PLAN.

This roof is of another and rather uncommon plan, and one which will be in-

side, and parallel to each wall plate; these are shown as E, F, and E, G.

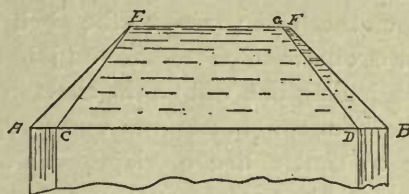

FIG. 5.

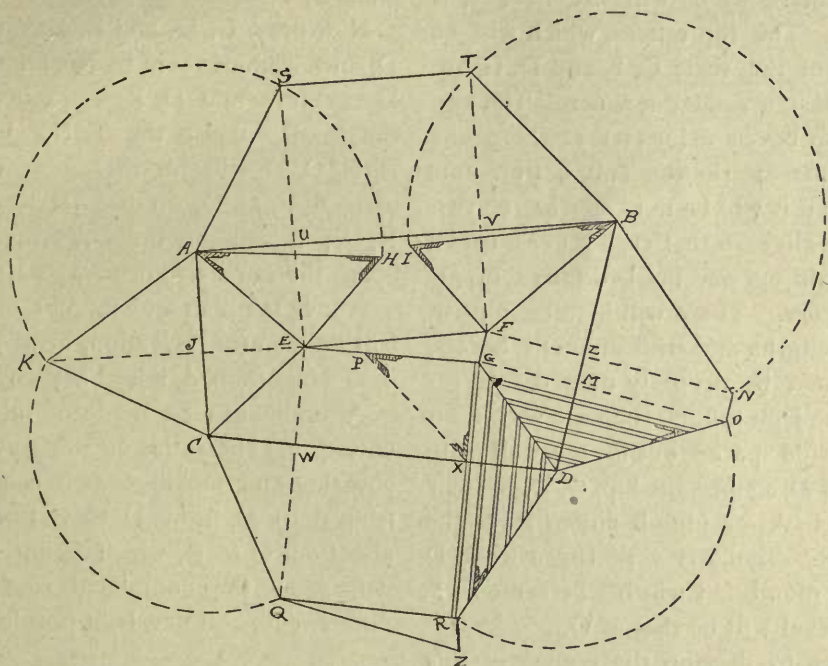

FIG. 4.

teresting to work out. It is a form of roof which sometimes occurs and will prove useful.

A, B, C, D, is the plan, Fig. 4, and it will be noticed that the side walls are not parallel, or at equal distance apart from end to end, but spread or widen out from A to B, and from C to D, or B, D, is longer than A, C. Similarly A, B, is longer than C, D, and not parallel to C, D. For this reason, coupled with the necessity of keeping the ridge level on both sides a

The seats of the hips as A, E, C, E, B, F, and D, G, are found by bisecting each of the separate angles on the plan, which can be done by taking any two points equidistant from the apex of the angle as A, and striking intersecting arcs. (As every carpenter knows how to do this, I will not illustrate it here.) This process will give the seats of the hips as shown and lettered, with the addition of a short piece of ridge F, G.

To find the lengths and bevels of the

rafters, proceed as follows: For the common rafters to range from U, E to V, F, on the one side, and from E, W to G, X, on the other side; raise up the pitch G, P. Square out from G to X, and join P X, which joining line will be the exact length of the common rafter from outer edge of plate to centre line of ridge. To obtain length of hip rafters square up from each point at the peaks, as E, H, F, I, on one side. Make E, H and F, I, each equal to G, P; A, H and B, I will be the lengths of the hip rafters, which will rise over A, E and B, F. The hip rafters, which will be set up over the seats C, E and D, G, are determined in a similar manner. The top and bottom bevels delineated at the peaks and bottoms are the top and bottom cuts of each, and it will be noticed that no two bevels are alike, so that each rafter must be carefully laid out and marked for each particular corner. There will be four hips of different lengths and with different bevels, so they must be properly framed. In regard to the jack rafters, they are shown on the right side spaced out on the wall plate from X to D, against the hip, G, D. Their top down bevel or plumb cut will be the side bevel. Similarly with those from D to M, the plumb cut will be the same as P, but the bevel will be that at O.

In order to develop the planes of this roof, commence by drawing E, U, S, from E, through W, at right angles to E, F, or A, B; also draw F, V, T parallel to E, U, S. Make A, S, equal to A, H by taking A as centre with radius A, H, and striking the arc H, S. Through S, draw S, T, parallel to A, B. If a centre be taken at B, and an arc struck as I, T, N, it will be found that the arc will pass through T, or F, V, produced at T. The surface A, S, T, B, will cover the plan A, E, F, B, on the pitch E, H.

Draw E, J, square to A, C, and produce

to K. Sweep H, S, to K, and join A, K, and K, C. A, K, C, will be the covering plane which will cover over A, E, C, on plan. For the plane of A, E, G, D, draw E, W, square to E, G, and produce to Q. With C as centre and C, K, as radius, strike the arc K, Q; draw Q, R, parallel to C, D. Join C, Q, which will be the centre of the hip rafter on this side. Draw G, X, square to C, D, and produce to R; join R, D, C, Q, R, D, will be the covering plane which will cover over C, E, G, D, on the pitch G, P.

Now draw G, M, and F, L, square to B, D, and produce them to N and O. With D as centre and D, R, as radius, describe the arc R, O, also the T, N. Join N, O, B, N, O, D, will be the covering of the plan B, F, G, D, on the pitch G, P. Q, R, Y, Z, will be the covering or deck, being the same size or area as E, F, G.

Above the plan and lay out of the roof will be seen the elevation, or as it will appear when framed, raised and covered.

A model can be made of this roof by cutting out the entire outside outline of the covering and making a slit from A to B, from B to D, from D to C, from C to A, also from Q to R, which being folded up will show the completed roof with the rafters, cuts and bevels in position.

CHAPTER IV.

PYRAMIDAL ROOFS.

Roof framing is a study well worth the attention of every carpenter. The roof illustrated and described in this chapter is one which occurs on many houses and cottages now-a-days. It is one of a kind of tower roofs on a square plan, or as they are sometimes termed "Pyramidal Roofs." A, C, D, F, Fig. 6, is the projection of the roof completed. A, C, D, B, Fig. 7, the

A, the bevel for the cuts on the plate. Concerning the jack rafters, the best way to determine their length is to set them off the plate as from A, to C, Fig. 7, then to draw a line as H, E, G, through E, parallel to AC, or BD. With A as centre and AF, as radius describe the arc FG, cutting the H, E, G, at G. Join G, A, and G, B, The triangle, or more properly speaking, the triangular surface G, A, B, will be the exact covering surface of the roof plane A, E, B.

From where the jack rafters come against the hip AE, draw lines parallel to E, G, and square to A, B, cutting A, G, as shown. The lines reaching from the plan line A, B, to A, G, will be the exact jack rafters and the bevel at K, will be the side cut against the hip, with the bevel at F, as the vertical cut, and that at K, the bottom or plate cut.

The development of the covering for the remaining three planes of the roof is found by drawing the line I, J, through E, parallel to A, B, or C, D, then with B, as centre and B, G, as radius intersecting E, J, at J, and joining J, B, and J, D; a similar process can be gone through to determine the points H and I, thus obtaining the four convexing planes.

To prove the accuracy of this and the two previous roof problems before described, or in fact any roof problem, the plan should invariably be laid out to a scale, say $1\frac{1}{2}$ inches to one foot. On a sheet of cardboard $\frac{1}{2}$ inch scale will do if the roof be very large, then to make a cardboard model. Here this can be done, and when the lines have been laid down, as just described, the entire model may be made as follows: With a sharp pocket-knife cut clean through the cardboard from A to G, from G to B, from B to J, from J to D, from D to H, from H to C, from C to I, and from I to A. Next make a slit half-

way through the cardboard from A to B, from B to D, from D to C, and from C to A. Proceed to fold the planes over the seats till they all join at the edges, thereby making a completed cardboard roof resembling Fig. 6, with the jacks and bevels in position, and with all the cuts fitting as they ought to.

CHAPTER V.

HEXAGONAL ROOFS.

Carpenters will see at Fig. 8 the top and side views of a hexagonal or six-sided tower roof, or one which has a wall plate

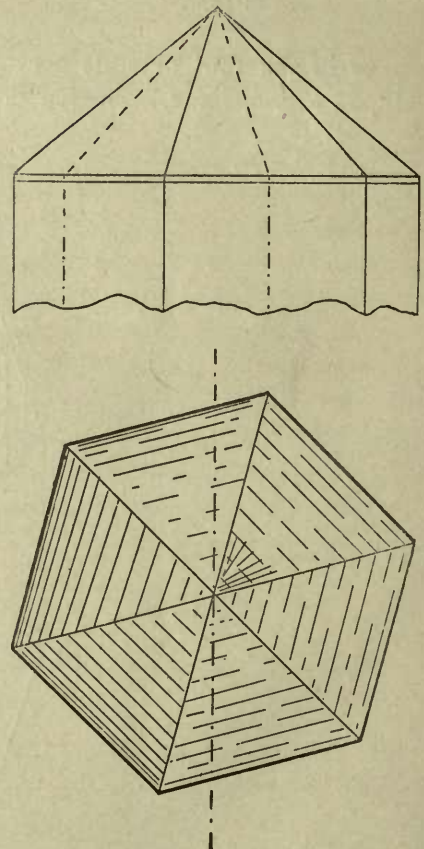

FIG. 8.

running round on six walls as shown, the dotted lines representing the angle lines of

the hexagonal figure. The completed roof with the tin or shingle on, will appear as shown on the lower sketch.

In order to frame this roof the following system should be used :

At Fig. 9 proceed to lay out on a board

G, as G, J. Lay off also to the same scale' the exact height in feet of the pitch or rise of the roof from G, to J, and join J, E, which line will be the exact length of the hip rafter as seen in the diagram with the top and bottom levels necessary for the

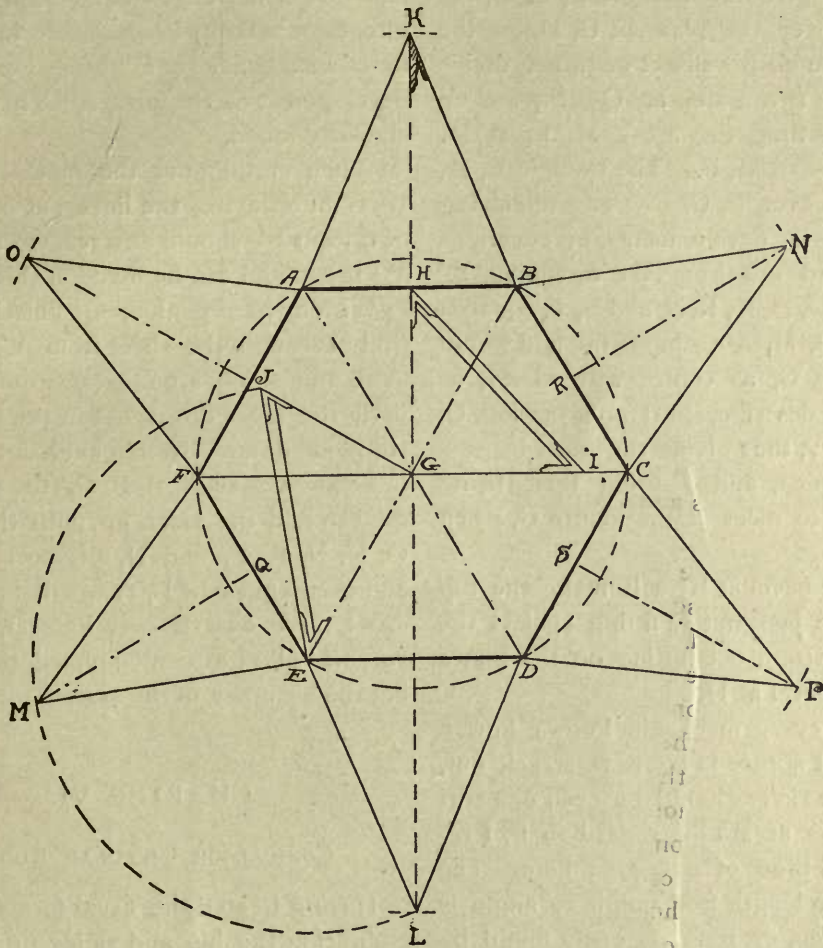

FIG. 9.

to a scale of $1\frac{1}{2}$ or 3 inches to the foot, the plan of the wall plates (on the outside line) A, B, C, D, E, F; and join the intersections of the sides, as A, D, B, E, and C, F; passing through the centre G. This gives the seats of the hip rafters A G, B G, C G, D G, E G, and F G, six in all To find their exact length, square up from E,

cuts, these being given at once without any uncertainty.

To find the length of the common rafter, to stand over, H, G, set off the pitch G, I, on G, C, equal to G J, and join H, I, for the length. This rafter is rarely used on roofs of this class, except when they are of large area, as only the jacks are requisite,

especially on modern frame houses where they seldom exceed eight feet in width, thus requiring short rafters.

To develop this roof take a pair of compasses, and with E, as centre, and radius E, J, describe the arc J, M, L, cutting H, C, produced in L. Join E, L, and D, L, which will give the triangle E, L, D, the covering over the plan E, G, D, on the pitch or rise G, J. Bisect or rather divide E, F, into two parts at Q. Square up from Q, cutting the arc J, M, L, at M. Join M, E, and M, F. The triangle E, M, F, will lie over E, G, F. The remaining four triangular developments or coverings can be laid out from the foregoing by making J, O, H, K, R, N, and S, P, equal in length to Q, M, or a simpler method would be to take G, as centre with G, M, as radius and describe short arcs cutting O, K, N, and P, thus giving the exact lengths at one sweep, and insuring their being alike so as to meet at the centre G, when folded.

The side bevel at K, will make the top cuts on the jack rafters fitting against the hips, the bottom cuts fitting on the plates being the bevel at H.

Almost every mechanic knows how a hexagon or six-sided figure is struck out, still in case there should be even one student who is at sea in regard to it, I repeat the method of doing so here. The diameter or length from angle to angle is usually given, or, if not, is easily found by joining the angles as before described. Now, to lay out any hexagon, draw any line as F, C, and divide it into two equal parts at G. With G, centre and radius G, F, strike the circle A, B, C, D, E, F. Now take a pair of dividers (sharp points on both legs) and from C, with one point on C, space out the six distances C, B, B, H, A, F, F, E, E, D, and D, C. Draw the lines as shown for the outline of the hexagon.

In regard to framing an octagonal or eight-sided roof, the same methods as have been described above can be safely followed with the exception of laying out the octagon itself, which can be done in any of the numerous ways now in use.

When the plan of the plate has been laid down, the angles are joined and the pitches raised up in the same manner as for a hexagonal roof. Likewise with the development of the planes. They can be similarly found.

When cutting out the model of these roofs (after laying the lines out on a sheet of cardboard, should any reader care to do so) the model can be made in this way.

With a sharp penknife or chisel cut entirely through the sheet from A, to K, K, to B, and so on around each outside line until the piece drops out in the form of a six-pointed star. Next make a slit through the plan lines as A, B, B, C, etc., and proceed to fold the sides up until the points O, K, N, P, L, and N, all meet over G, and each hip as E, L, etc., will be in their exact place, exactly over its seat, and the cuts will all fit as contemplated, thus proving the accuracy of the system.

CHAPTER VI.

CONICAL OR CIRCULAR ROOFS.

Having treated the usual forms of roofs embracing the hip and valley principles, I will now draw the attention of my readers to the proper laying out and framing of a roof on a circular tower, as this form occurs very often in modern houses, barns, etc. The methods to be followed are very simple, so that an ordinary mechanic can easily understand them if he only studies the diagram and text a little.

Supposing A, B, C, D, E, F, G, H, on Fig. 10, to be the plan or plate line of the

roof, and O, L, the pitch or rise, it can be laid out as follows: To be more explicit, I will take it for granted that a carpenter has a roof to frame with a plan A, B, etc., 6 feet diameter, or 6 feet from C, to G, and 9 feet rise, or from O to L is nine feet. Proceed to strike the plan A, B, etc., either to full size or to scale. It is always better to lay out full size if a floor or drawing board can be found large enough to do it,

The ONE AND A HALF inch scale is similar, but the divisions are not so handy. For instance:

1½	inches	=	1 foot.
¾	"	=	6 inches.
½	"	=	4 "
¼	"	=	2 "
⅛	"	=	1 "
⅙	"	=	½ "
⅓	"	=	¼ "

The above two scales are the best work-

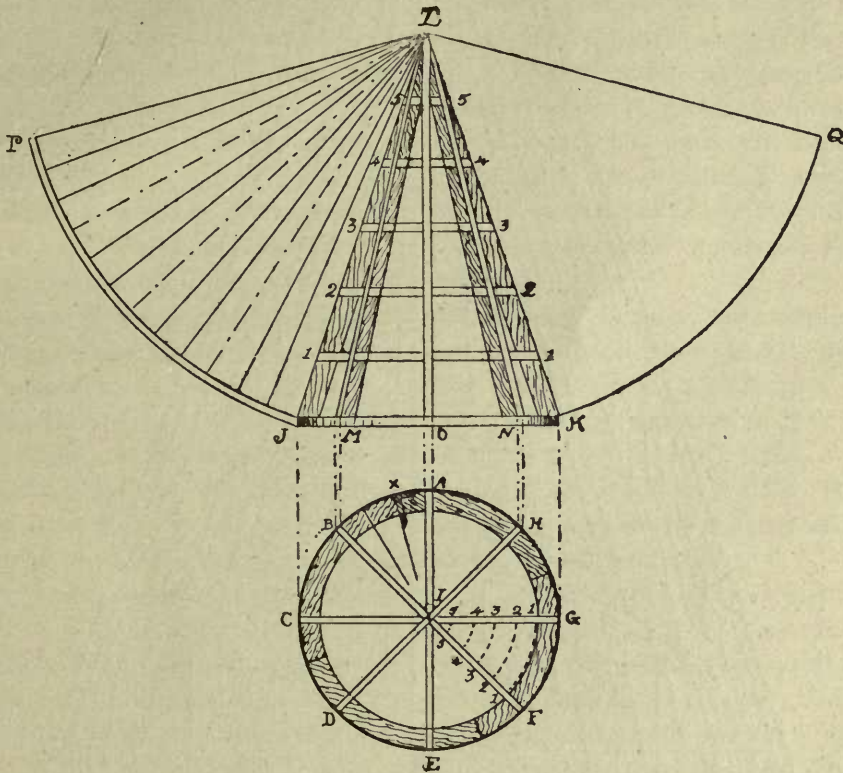

FIG. 10.

but if not, half size or a scale of 3 inches or 1½ inches to the foot may be used. The reason these are the best working scales is because the THREE INCH SCALE works as follows:

3	inches	=	1 foot.
1½	"	=	6 inches.
1	"	=	4 "
½	"	=	2 "
¼	"	=	1 "
⅛	"	=	½ "
⅙	"	=	¼ "
⅓	"	=	⅛ "

ing scales, with the exception of the half size proportion, which is very simple and easily applied, thus:

6	inches	=	1 foot.
5	"	=	10 inches.
4	"	=	8 "
3	"	=	6 "
2	"	=	4 "
1	"	=	2 "
½	"	=	1 "
¼	"	=	½ "
⅛	"	=	¼ "
⅙	"	=	⅛ "
⅓	"	=	⅙ "

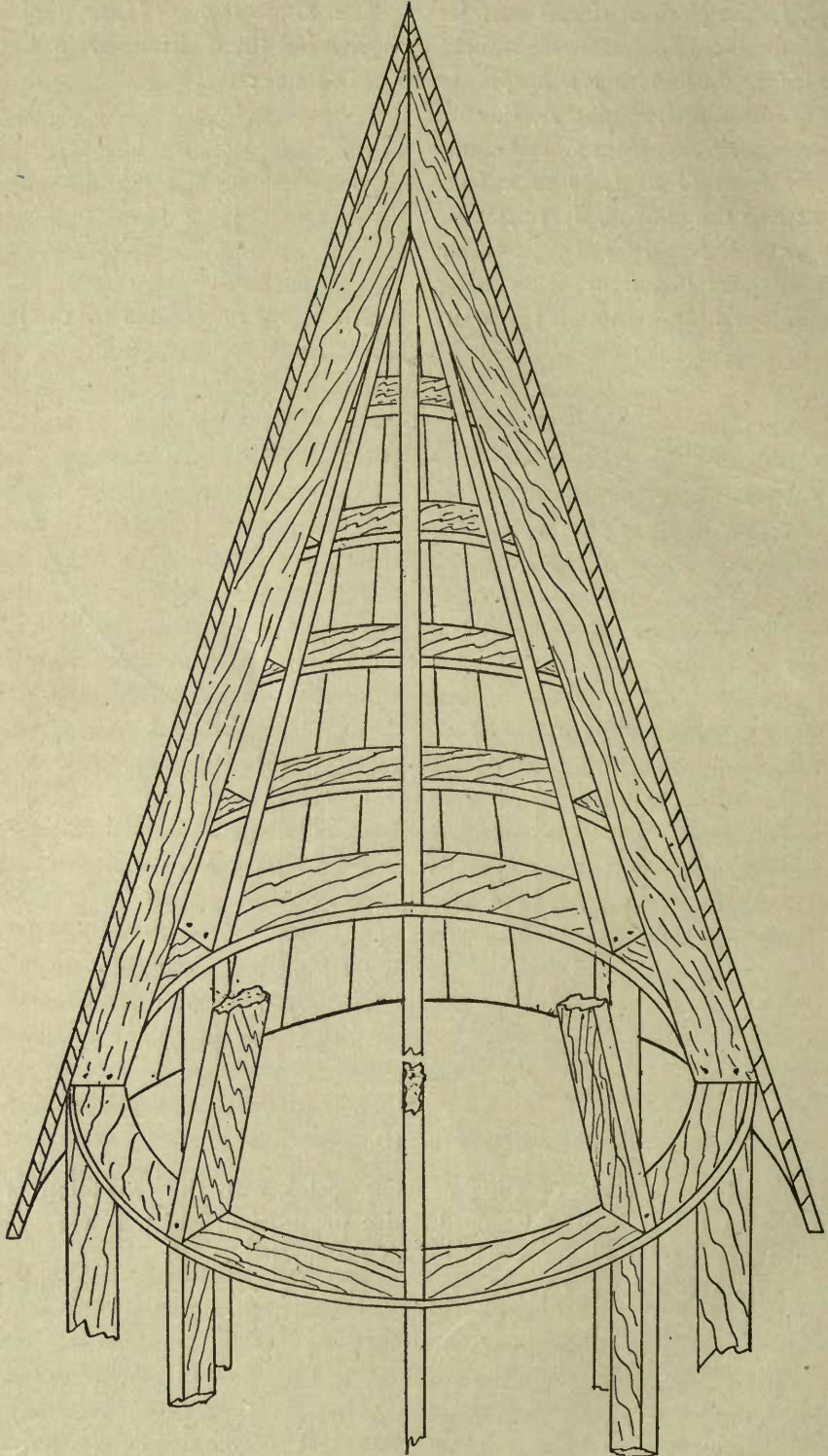

FIG. 11.

The foregoing scales are the best for carpenters, either foremen or at the bench, but, as I said above, the full size laying out is the best. Whether the work is laid out to scale or full size, the exact measurements should always be marked in plain figures on every piece.

Having struck the circle, draw centre lines for the rafters A E, B F, C G, and D, H, and set off the thickness of the rafters as they show on the plan. Next draw any straight line as J K, the same length as C, G; raise up the centre line O, L, the height of the pitch, and join L K, which will be the length of the rafters to stand over A I, B I, C I, D I, E I, F I and G I, and the top and bottom cuts will be directly given; as at L and J, L M, and L N, are the rafters I D and I E placed in position and L O is the rafter E I in position. By referring to Fig. 11, the rafters B I, A I, and H I will be seen at the rear of the figure.

If the roof is to be boarded vertically, horizontal strips or *sweeps* will require to be sawn out and nailed in the manner represented in both Figs. 10 and 11. To do this properly, divide the height from O to L in Fig. 1, and draw the lines representing the sweeps as 1 1, 2 2, 3 3, 4 4, 5 5. Their neat length, and the cuts to fit against the sides of the rafters, may be determined by striking out the sweeps shown on the plan, 1 1, 2 2, 3 3, 4 4, 5 5. It will be noticed that this roof will require 8 circular pieces for each row, or 40 sweeps in all. One pattern will do for each sweep and the remaining eight needed can be marked from each pattern.

Fig. 11 will convey a better idea of the constructed roof, as this illustration represents each stud plate, rafter and sweep in its fixed position, with the covering boards nailed on half way round.

In order to find the exact shape and bevels for the covering boards, a very

simple method is used, thus: Take a pair of compasses, or a trammel rod, and with L as centre, and LP as radius, describe the arcs JP and KQ. Join LP and LQ, now divide the half circle A, B, C, D, E, into 12 equal spaces on JP with a pair of compasses, and join the division marks on JP with L. This will give 12 tapering boards and the bevel at X on the plan will be the bevel of the jointed edges. As twelve boards will be needed for half the plan, twenty-four will have to be cut out for the other half, so it will be seen that if the sweep or arch JP goes round from AB to E, the sweep KQ will go round HKG, etc., to E. The diminishing lines from the point L to the line JP are the inside lines of the joints of the boards shown also in Fig. 11.

In order to prove the rectitude of the foregoing, a model can be made by drawing the roof to scale on cardboard, and then cutting out the figures from L to J, from J to K, and from K to L. Also cut out the figures LPS, and LQK. Now if LSK be stood up over AEBF, etc., it will be seen to fit over each other.

In a similar way the figure LJP will bend round ABCDE with the peak L over the point I and the line JP around ABCDE. In a like manner KQ will bend round AHGFE, and L will lie over I, thus proving the correctness of the methods followed. Care must be taken to allow for the intervening rafters, when framing the peak cuts of the rafters.

All my roof diagrams are laid out to a scale as all plans are and usually must be so that if any carpenter finds for example, that any rafter or number of rafters rises, say ten feet on the plan and has a run of 15, 18, or 20 feet as the case may be, all he has to do is to assume every inch on the steel square to be equal to a foot or 1 inch scale, and take ten inches on the tongue

and 20 inches on the blade, the blade angle will give the bottom cut, and the tongue the top or peak cuts. I have followed this simple method in working from plans and it has never failed yet.

CHAPTER VII.

FRAMING, SHEETING AND SLATING AN EYEBROW WINDOW.

I here have pleasure in publishing the proper method to be followed in doing this job, and many may appreciate the information as this form of attic window is becoming more popular every year; in fact, replacing the old fashioned dormer in low pitched roofs or those on cottages in the Queen Anne or Colonial styles.

At Fig. 12, assume A B to be the length of the window, in this case 6 feet at $\frac{1}{2}$ inch scale, and the height 3 feet. Draw the centre line D C, and the end line from A and B, square to A B, the sill line. Now draw the outline of the window, as A E, B, and the sash and frame to the *eyebrow* outline seen in the engraving; at 4 foot radius.

Next proceed to Fig. 13 the section, and draw the house rafter on its pitch, and at the distance up from the cave of the roof draw the sill and height of the window, 3 feet.

Assuming the eyebrow window rafters to be *concave*, or hollow, strike them out at 8 feet radius and locate the point *c*, Fig. 13, where the covering of the window roof intersects the main roof. Now divide the curve of the eyebrow into equal parts and transfer these over to Fig. 13, as seen, and with the 8-foot centre and patterns, draw the curves of the rafters according to the number desired, that is, if the roof is boarded across or horizontally—3, 4, 5, 6,

7, 8, etc., will be the curve and length of each rafter, and be set up as they are shown on the right side of Fig. 12. Now draw from Fig. 13, back again to elevation, the points where the curved rafters die into main roof and draw up square to sill from division points on curve. The intersecting of these lines will give the curve C B, Fig. 12, which will be the shape of the valley on the roof. If desired, the vertical rafters can be sheeted with $\frac{1}{2}$ inch pine strips, bent round in two thicknesses, and well nailed to each rafter and breaking joint in each thickness. Another way to frame this roof is to use horizontal, instead of vertical, curved rafters, in the way shown to the left of Fig. 12, each rafter following the outline of the front elevation of the window and dying into the roof as it curves upward. In this case also the sheeting board must be bent. Three thicknesses of 3-8 in. x 2 in. pine strips, laid breaking joint, make a reliable sheeting, and one slating nails can be nailed to.

Regarding slating or shingling the roofs of these windows, I would state that the first course should follow the curvature, and project over the front of the window and continue horizontally up. The slates should be very narrow and may radiate from the valleys.

HOW TO STACK LUMBER.

All timber, especially that which is to be used in the construction of a frame house, should be properly piled or stacked up adjacent to the building until the building is ready for its use. When the stuff is dumped from the wagon it should immediately be put into piles according to the different sizes of the timbers; for example, all 2"x4", 2"x6", 2"x8", 2"x10", and so on should be kept in separate piles according to their lengths, as ordered in the lumber bill, in a manner to allow the air to

circulate around each stick and permitting water to fall through, without remaining on the timbers. Piles should in every case have blocks set under them so as to pre-

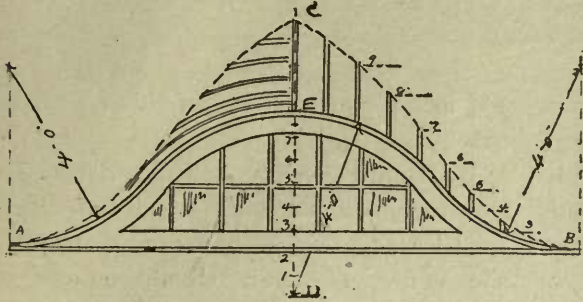

FIG. 12.

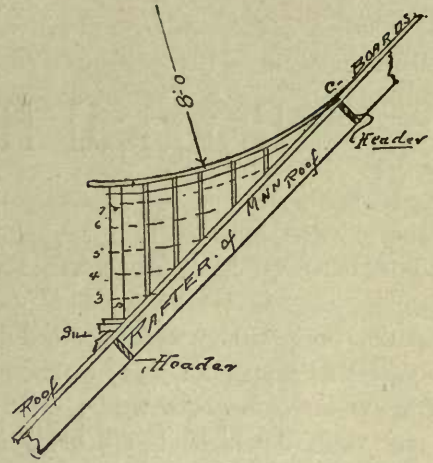

FIG. 13.

vent those next the ground absorbing the dampness therefrom. If the pile be very large, as in the case of sheathing boards, it should pitched slightly from end to end to permit the water to run off. Should flooring be brought to the building before the roof is on, it should be very carefully stacked in layers with strips intervening between each layer, and the top of the pile should be carefully covered with rough boards and over-lapping and breaking joints in such a way as to prevent any rain from wetting the stuff. This is absolutely necessary if the flooring be of white pine and kiln dried; as, on account of the extreme sensibility of the wood to dampness, it will expand if wetted and contract again when laid and subject to the heat of a room. It is always best not to have flooring, wainscoting and trim come to the

building until after the roof is entirely completed. The same care must be used in stacking corner boards, clap boards and other outside finish as applied to flooring. The best method, however, is to have all the outside finish primed before sending to the job.

The following figures on the steel square give common rafter cuts on steel square for different pitches; also hips and valleys.

For

$\frac{1}{8}$ pitch	take 3	in. rise	12 in. level or plate
$\frac{1}{6}$	"	4	"
$\frac{1}{5}$	"	$4\frac{8}{10}$	"
$\frac{1}{4}$	"	6	"
$\frac{1}{3}$	"	8	"
$\frac{1}{2}$	"	12	"
$\frac{2}{3}$	"	16	"
Goth.	"	21	"

For hips and valleys substitute 17 inches on level or plate for 12 inches.

Practical Hints for Carpenters.

THE IMPORTANCE OF ACCURATE MEASUREMENTS.

One of the things which is not sufficiently considered by the majority of mechanics is the value of measurements, and the care and method which should be followed in obtaining them. Let us consider the part they play in mechanical procedure, especially that which pertains to the practice of carpentry and note the result.

What are measurements? They are the distances between points or the actual sizes of constructions or details of constructions, and being determined either through the system of scale drawings or by other constructions already completed, must of necessity be absolutely correct to ensure success and accuracy in all mechanical operations.

Now as to the best methods of obtaining accurate measurements. In this it has been found that the methods vary with the distances or detail to be measured, and different details will require different methods.

I would say, that every distance must be found exactly and by systematic means, and for long distances, the metallic or steel tape-line, as used by engineers and surveyors, is most useful. In laying out and measuring lots and sites for houses it should be employed, or for long distances or materials, but for materials such as timbers not over 30 feet, the writer has found the 10-foot pole the best measuring instrument. This valuable tool should be thoroughly understood by every mechanic. It consists of a simple pole or rod of wood, exactly 10 lineal feet long and from 1 to

1 $\frac{1}{4}$ inches square, made of either pine or oak.

It should be well seasoned and laid out absolutely accurate in feet on all four sides, or at least two sides, commencing at opposite ends. The lines should be cut in deeply with a chisel so as to be indelible, and the figures (Roman) thus: I, II, III, IV, V, VI, VII, VIII, IX, X, cut in deeply with a $\frac{1}{2}$ inch or $\frac{3}{8}$ inch chisel. By doing this they will be permanent and not liable to be rubbed off as they would be if laid out in ordinary pencil marks. If made in the above way or even out of an inch by two strip, this tool will be found of great value in measuring framing timbers for houses, in laying off windows or doors, setting out partitions, or in fact any work outside the measuring capacity of a carpenter's two-foot pocket rule. Especially will it be found necessary in measuring roof timbers where absolute accuracy is essential; great care should be taken to see that it is not broken nor less than the full 10 feet, as it would make a very serious lessening in the entire length supposing the pole were laid on a long stick.

To measure the distance between two walls or in openings as framing for doors, windows and in recesses, the best method is to use two rods by sliding them along until the ends touch the opposite side, thus obtaining the exact width. If in door openings, as for jambs and windows, the width should be taken at the top, bottom and middle, so as to verify and approximate the average width should there be any variation. Similarly in regard to heights,

as heights of doors, windows, ceilings, floor beams, etc., the two rods are safest, as they cannot bend, and if held with both hands and slid apart the exact distance will be ascertained, as it is a very simple matter to measure the length of the rods. Two two-foot rules are also of great utility in inside measuring.

In conclusion, I would recommend mechanics to be more particular and spend more time on the process of measuring, and note down any peculiarities existant in the construction and make line sketches and remarks about same, especially when measuring up for new work.

LAYING OF FLOORING.

Concerning the laying of flooring. I have lately noted there might be much said on this important detail of building construction. First, as to commencing to lay. I would suggest that the first course be laid perfectly straight, being composed of perfectly straight, picked boards, and laid to a line or straightened through from end to end with the eye, and it should be firmly nailed down before commencing to drive up the second course. Second, flooring should go together comparatively easy; that is to say, the tongues and grooves should fit snugly, but not so tight as to necessitate bruising up all the tongues of each succeeding board, or line of boards, by banging it to splinters with a hammer or axe. Third, the running joints should be driven together tight by using a block of hard wood and a heavy mall, so that the flooring board will not recoil or spring out. If it be rounding or hollow one man should drive it to a tight joint and hold it there while the other nails it solidly to the beam below. Fourthly, heading joints should be absolutely tight and might be bevelled a little under in the sawing, in order that the face of the board may be

tight, and no two joints should be on the same floor beam not closer together than the spacing of two beams apart, nor should two joints be on any one beam with only one through course between. There should be always two or more between. The heading joints should likewise be well scattered to avoid their being conspicuous, and not, as is often done, all grouped in one, two or more places. All the above suggestions are, however, subject to modification, in order to suit the stuff, so as to use it without waste or loss of time. All head joints rising too high above the surface of the floor must be planed off. Nailing should be done carefully and without splitting the tongues off.

A word as to the ordinary mortise and tenon joints on framing. From close observation the writer has found that it is necessary for a carpenter to study the nature of his stuff closely, in order to construct work of this class so that it will remain a level surface without warping, especially when the framing (as in the case of a framed or panelled door) is suspended or so placed as to be subject to change from not being fixed or nailed in position, as is wainscoting, jambs, soffits, back-linings, etc. If, in laying out, the stuff be not considered and *matched* so as to warp in the proper direction, the result will be a useless job. To exemplify this, I would say that very often the stiles of a door will warp one to the inside and the other to the outside of the door, leaving it hopelessly in wind, and this could be avoided in the laying out, reversing the stiles so as they would both work in the same direction, and thus keep the door comparatively level. This is, of course, entirely unnecessary in the case of veneered doors, as I now refer to pine and whitewood or poplar doors where the varying grains occasion so much trouble as to render some of the timber unfit for

use. In fact, so much is this evident, that the writer has often had occasion to find that it is often more profitable and satisfactory to make pine doors with cores and veneer than out of the solid stuff.

HOW TO PUT ON HARDWARE.

Ordinary brass faced mortise locks need nice fitting and require to be set in flush with the door's edge and not to project if the edge be beveled. Brass door-knobs and escutcheons ought, in all cases, to be covered with linen to prevent rough, sandy hands from scoring the polished surface. Tie the keys to the knob, or, if this be risky, put a marked and numbered tag on each, in order that its lock may be readily found.

Door springs have also printed directions which must be adhered to to insure satisfactory working. Yale and other special locks need special cutting, and therefore a good mechanic to put them on right, but the directions and sketch in the box are a wonderful aid to novices. These locks ought never, under any circumstances, to be taken apart, on account of their intricacy. An error of this kind once cost the writer much expense and delay and a good drenching bringing it to the manufacturer's depot for readjustment.

In regard to sash locks there is little to be said, except that they require to be on so as to really lock the window, namely, bind it close together at the meeting or check-rails, besides preventing the sash from being moved. Fasten on escutcheons perfectly plumb and drawer-pulls level, and try and keep the slots of the screws in a line with the work. For instance, in escutcheons, finger plates, hinges and lock faces, keep all the slots plumb, and on drawer pulls, door pulls, or any brass or iron or silver work, keep them level or horizontal. English ship-joiners never put their screws in any way but this, and it really makes the hardware much neater, and is worth following even at the expense of an extra turn of the screw-driver.

The hardware of sliding doors consists of the sheaves or rollers, the track on which

they run, the lock and fittings, and the iron door-stop above.

For fitting in the sheaves, the main thing is to get them in the centre of the edge, to bring the two doors fair and to have them project equally. The doors ought, of course, to be fitted till the joint comes close, and when the inside wood stop is mortised in and cut, the two can set on the track, which, by the way, comes in two lengths, and the sheaves regulated till the doors close tightly. Allow enough from floor for carpet-saddle. The stop is let flush into the door-head, and the lock put on the usual way. Hardwood sliding doors should never be made without *friction strips*, to save the arises and faces of the door surfaces.

Fanlight levers, bolts, etc., are comparatively simple in their application, and demand little or no direction, but the great thing to watch in putting on all hardware is to make it fit neatly, so that it may look well. All marking should therefore be exact and done with a knife to insure the piece to fit in its place and work freely, without sticking.

NAILING OF FRAMING, ETC.

Let me draw attention to the fact that much more care than is usually evinced might be taken by carpenters when nailing parts of framing together, especially at the abutting ends of studding, on the top and bottom cuts of rafters and such like. As a rule I find that many of the pieces are split out by careless or insufficient nailing, which is done so as to split or splinter off the stuff and lessen its holding capacity. This could easily be avoided by entering each nail more carefully. Another thing is to be sure and straighten all studding, flooring, beams and roofing timbers through from end to end, so they will be set rigid and upright, in order to gain their utmost strength. If any timbers be warped they should be straightened up or bridged in some way so they will not twist more. The foregoing I would especially apply to hemlock and spruce, as many pieces are warped and need a little care.

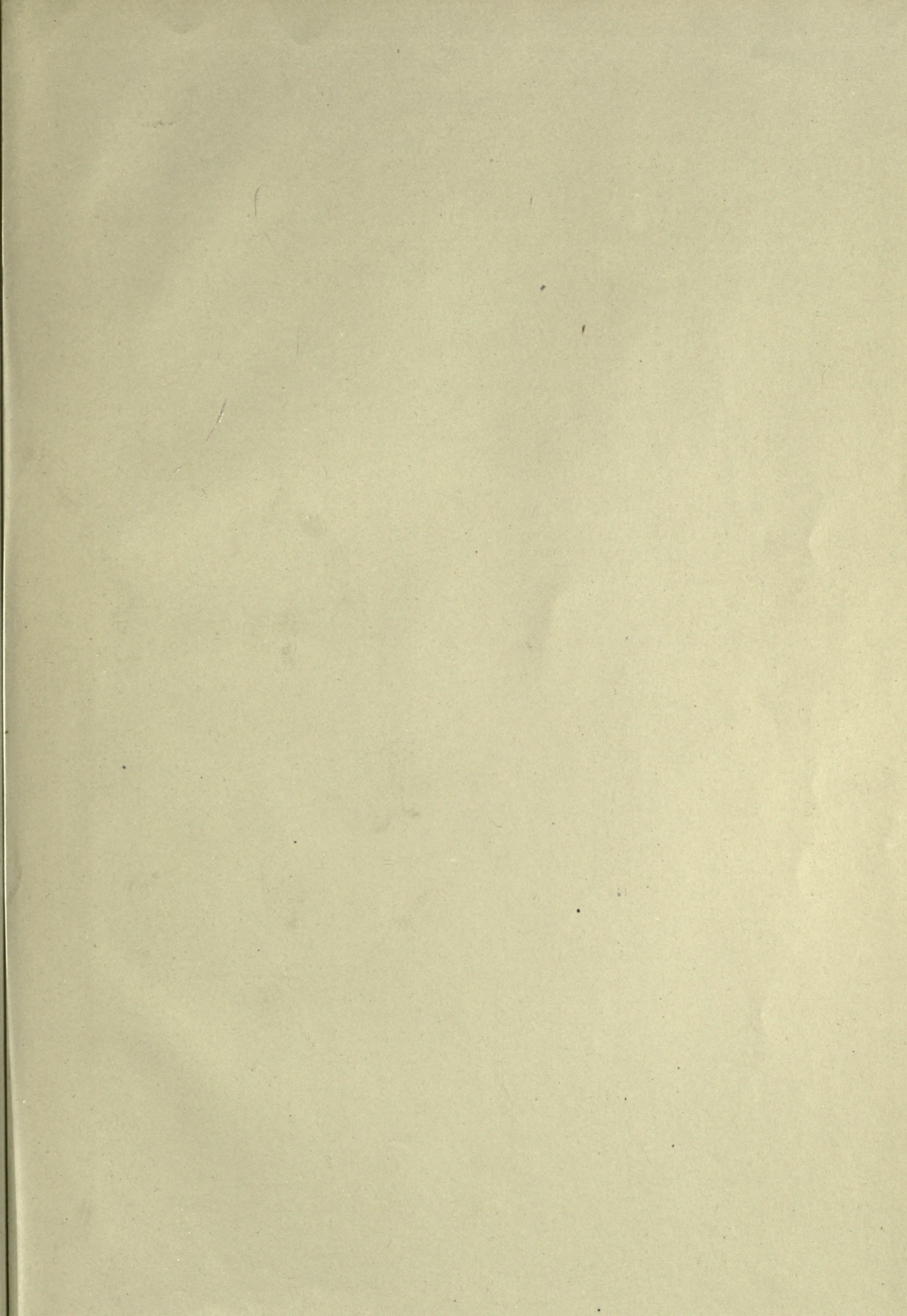

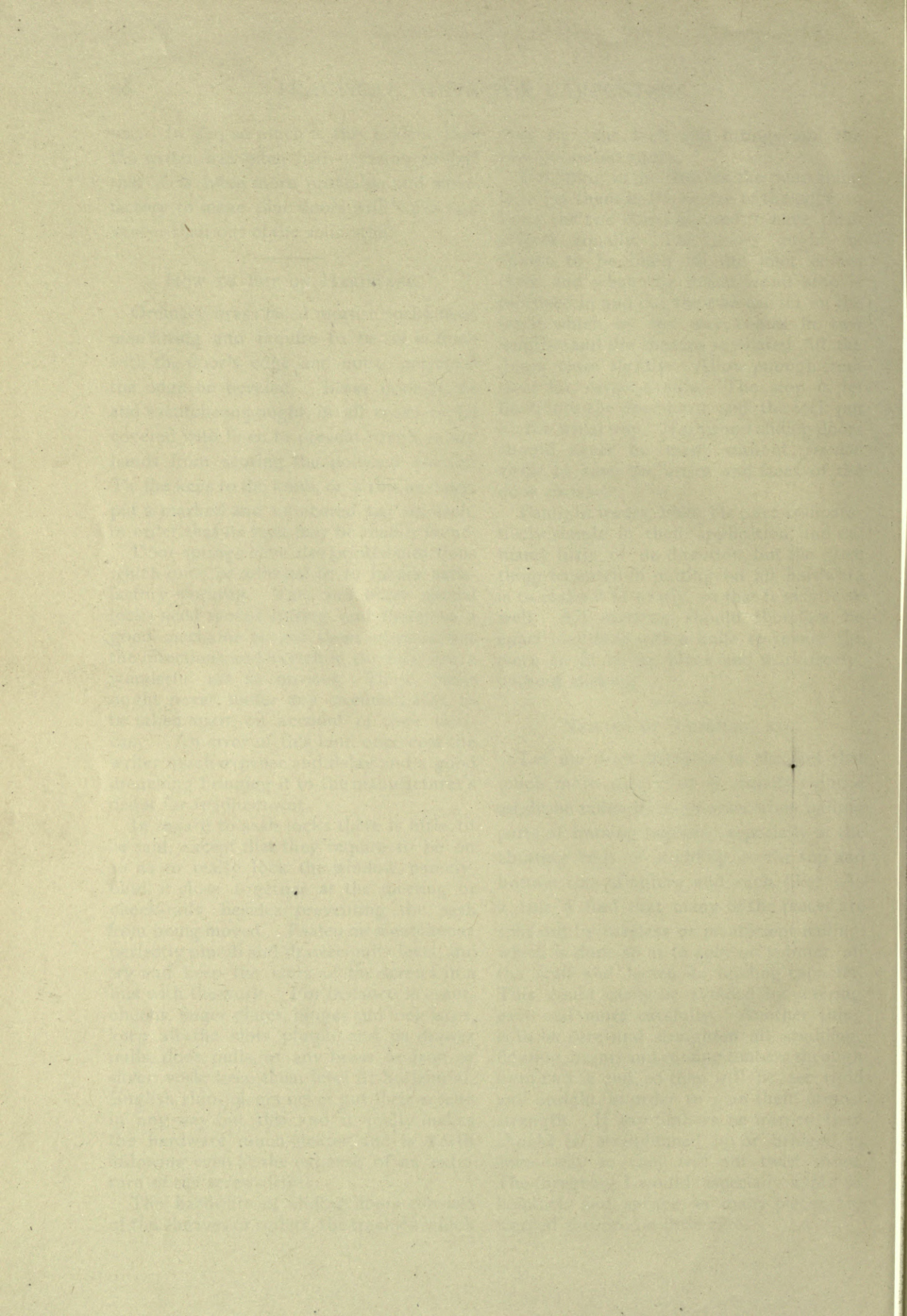

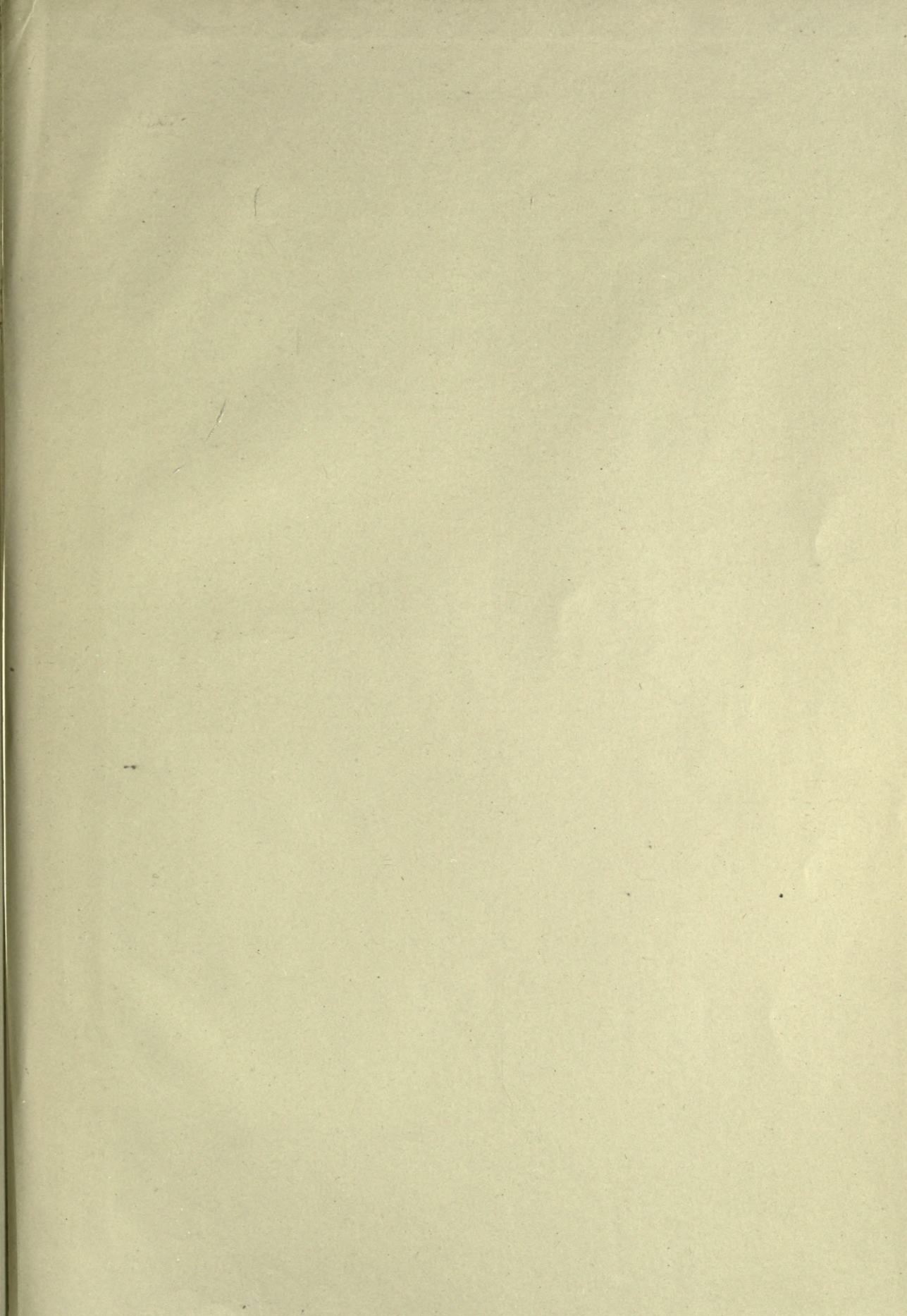

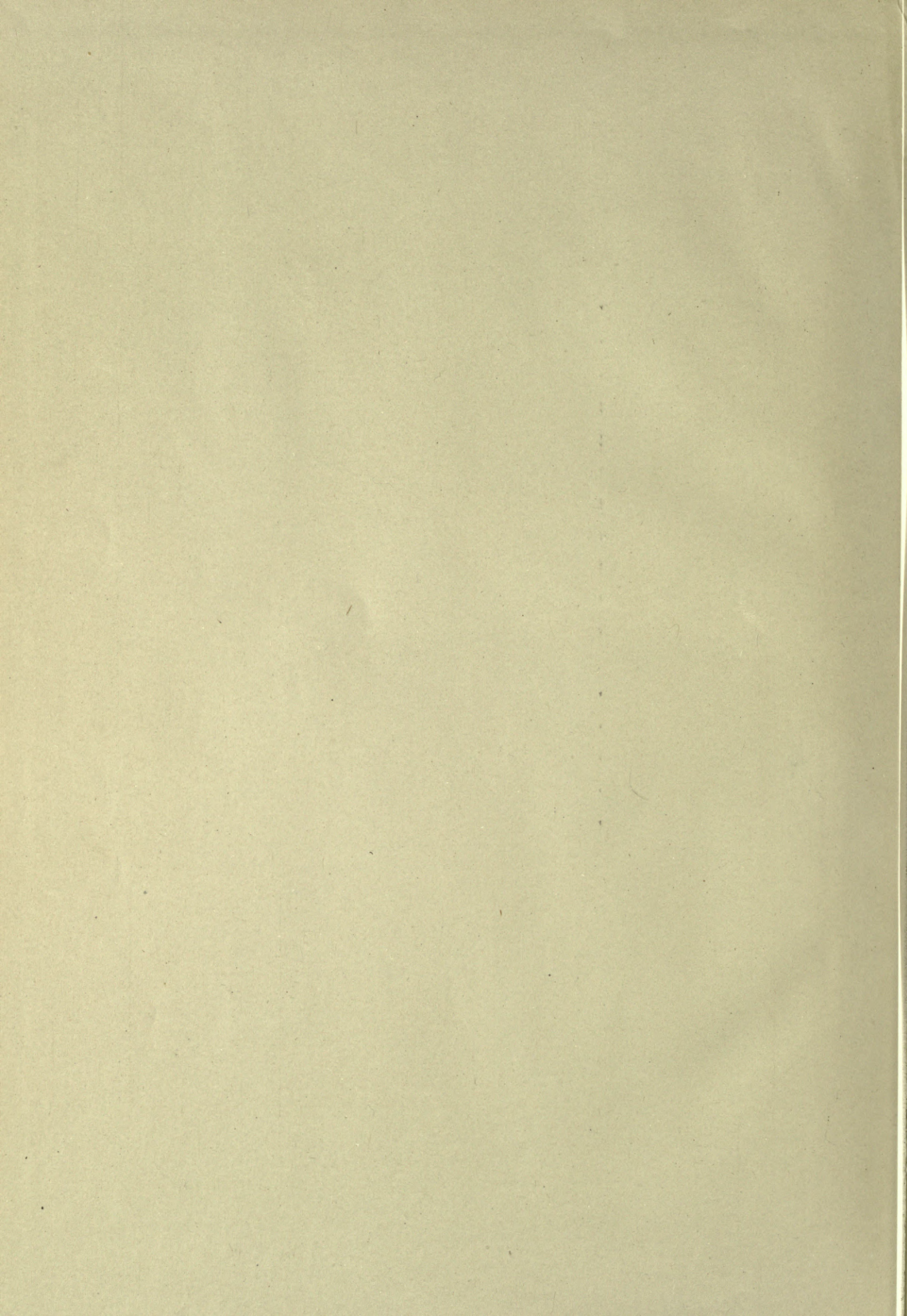

UNIVERSITY OF CALIFORNIA LIBRARY
BERKELEY

Return to desk from which borrowed.
This book is DUE on the last date stamped below.

28 Nov 5 TRP
14 Nov 51 LV

17 Nov 80 D 1

2 Mar '55 DP
FEB 16 1955 LU
21 Feb '57 PW

REC'D LB
NOV 16 1960

REC'D LB
FEB 13 1957

APR 2 1971 6 7
REC'D LB MAR 23 71 - 10 AMO 7

28 Nov 58 P T

REC'D LB
NOV 21 1958

LD 21-95m-11, '50 (2877s16) 476

YD 02774



